

arcoPlus®
344x

arcoPlus®
347 547-549

Technical book



Informationspaviljong Stockholmsarenan
Öppet dagligen Välkommen in!

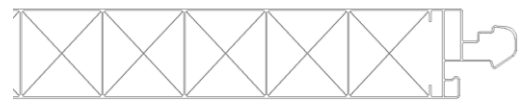

344X

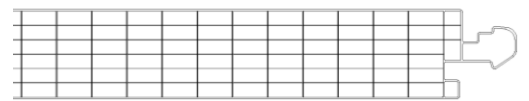

347

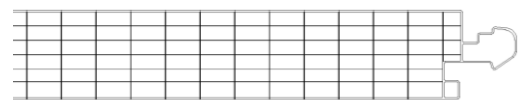

547

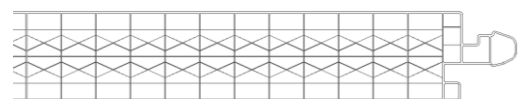

549

Introduction

This technical book has been developed by our Technical Sales Department, relying on our internal technical expertise.

Our Research & Development department deals with two main responsibilities:

- To develop new innovative systems ;
- To bring its expertise to attend our customers and our technical and sales team in dealing with current complex projects.

Our R&D department has played a major role in providing the market with innovative polycarbonate systems solutions for over 10 years. For instance, its expertise led to such unprecedented polycarbonate applications as:

- Prada Foundation in Milano.
- Gorky Park Museum in Moscow.
- Multipurpose hall in Cluji.
- “Il Centro” Mall in Arese.
- Protoshop Lamborghini in Sant’Agata Bolognese.
- “Centro Sicilia” Mall in Catania.

Our Technical Sales Department team works in close connection with the various technical departments in CSTB, LNE and GINGER in order to finalise new systems and specific solutions to complex projects falling out from the Technical Certification perimeter.

Index

	Page
System definition	4
Thermal expansion	4
Technical assistance	4
Panels specifications	4
Thermal specifications	5
Acoustic insulation values	5
Optical characteristics	5
Fire reaction	5
Resistance to chemical agents	6
Storage	6
Maintenance	6
How to replace a damaged panel ?	6
Permissible loads graphic	7
Details, cross sections, 3D images	9

1 – System definition

ArcoPlus® Interlocking systems 344X-347-547-549 have 40mm thickness. They can be used without any restriction of width or height to create lighting glazing for applications such as cladding or roof “saw tooth”. They are made of cellular polycarbonate panels, anti-UV co-extruded on one side (or two sides upon request) and they are assembled vertically by interlocking of longitudinal ribs.

Those systems can be used for any building type (industrial, air-conditioned offices, schools, hospitals, sport centres, housing, swimming pool, etc ...), would they be heated or not, however not refrigerated. They can be installed with a maximum slope of 15°, including for “saw tooth” application, and they can also be installed in any humidity level (high or low) environments (ie: swimming pools).

ArcoPlus® systems do not contribute to the functions of loads transmission, bracing and shock resistance for security purpose (railing function). Those functions are performed by the supporting structure.

Any application falling out from those criteria can be submitted to our technical department to be assessed within a specific analysis.

2 – Thermal expansion

The linear expansion coefficient is 0,065mm/ml/°C. The precise expansion of a panel can be calculated with the following expression: $\Delta L = \alpha \times L \times \Delta T^\circ$

ΔL : Thermal expansion;

$\alpha = 0.065 \text{ mm/m}^\circ\text{C}$;

L= panel's length;

$\Delta T^\circ =$ estimated temperature in Celsius degrees.

While installing the panels, it is essential to check on the polycarbonate panels covering section (R in mm) of the aluminium profile according to the following chart:

T° C Installation	Panel length in meter								
(L)	1	3	5	7	8	10	12	14	16
0°c	20 mm	23 mm	25 mm	27 mm	29 mm	30 mm	31 mm	33 mm	37 mm
15°c	22 mm	26 mm	31 mm	35 mm	39 mm	41 mm	44 mm	47 mm	53 mm
30°c	23 mm	30 mm	36 mm	42 mm	48 mm	53 mm	56 mm	60 mm	70 mm

Panels are freely expanding towards the top within the connectors and the top lateral profiles.

3 – Technical Assistance

Technical assistance and distribution in Italy and abroad is realized by dottor Gallina srl, based in La Loggia (TO). The company analyse the solution best suited to the project and develop a detailed list of panels, profiles and accessories required for the installation.

Even though dottor Gallina does not install, the company can attend the beginning of the implementation and provide advices at customer request.

4 – Panels specifications/treatments

	344X	347	547	549
Width (mm)	333±3	333±3	500±3	500±3
Thickness (mm)	40±0.3	40±0.3	40±0.3	40±0.3
AR	X	✓	✓	✓
IR	X	✓	✓	✓
Bi-coloured	X	✓	✓	✓
UV Tech	✓	✓	✓	✓
UV Matt	✓	✓	✓	✓
AG	✓	✓	✓	✓

AR : Anti-glare treatment (visual comfort, prevent from neon effect)
 IR : Infrared treatment (prevent from heat increase within the building)
 UV Tech : Reinforced UV Protection – 15 years warranty.
 UV Matt: Matt finishing treatment (prevent from surface glares, better distribution of the light)
 AG: Anti-graffiti and anti-scratch treatment.

Panels are available in various colours, included in our “Caleido” range. Due to extrusion process constraints, a visual difference in colour shade is admitted as long as it does not interfere with the mechanical characteristics of the polycarbonate components. Some treatments like AR (anti-glare) and IR (infrared) can create some shade variations with colour range.

5 – Thermal specifications

	344X	347	547	549
Uc (W/m ² .K)	1.70	1.10	1.10	1.00
ψi (W/m.K)	n.d.	n.d.	n.d.	n.d.
χk (W/k)	0.005	0.005	0.005	0.005

Uc : Thermal coefficient in the core part of the panel (in between connectors)

ψi et χk : Thermal coefficient alongside the connectors.

6 – Acoustic insulation values

	344X	347	547	549
Internal	18 dB(A)	n.d.	n.d.	1.00
External	16 dB(A)	n.d.	n.d.	n.d.
Rw (C,Ctr)	19 (-1,-4) dB	21 (-1,-4) dB	21 (-1,-4) dB	21 (-1,-4) dB

Acoustic test according to regulation ISO 140-4 e UNI ISO 10140

7 – Optical characteristics

	344X		347		547		549	
Colour	Crystal	Opal	Crystal	Opal	Crystal	Opal	Crystal	Opal
Light Transmission (LT) in %	72	49	54	31	54	31	50	28
Solar factor (SF) in %	77	60	58	46	58	46	57	46

Light transmission (LT): Different pigments are used to obtain different light transmission values. The values indicated in the tables are based on calculations performed at specialist laboratories.

Solar factor (SF): Incoming solar radiation is reflected, partially absorbed, and transmitted to the inside. The solar factor indicated in the table is the ratio, expressed as a percentage, between the total energy transmitted to the inside and the total solar radiation.

8 – Fire reaction according to EN 13501-1

	344X	347	547	549
Fire classification	B,s1-d0	B,s1-d0	B,s1-d0	B,s1-d0

9 – Resistance to chemical agents

The polycarbonate has good resistance to most chemicals with which it is likely to come into contact during normal use. Specific tests are recommended for applications where the material is likely to come into contact with aggressive chemicals. It is essential to verify their compatibility prior to use. Below some examples:

Chemical agents	Resistance
Diluted acids	Good
Concentrated acids	Average to good
Alkali	Low to average
Organic solvents – alcohol	Good
Chlorinated hydrocarbons	Good
Aromatic hydrocarbons	Good
Aliphatic polycarbons	Good
Lubricating oils	Good
Detergents	Good

10 - Storage

ArcoPlus® systems should be stored avoiding exposure to direct sunlight and rain. Should storage be outside, it should not be directly in contact with the ground (a ventilation space must be kept) and should be protected with a light coloured non-transparent tarpaulin.

To avoid oxidation, untreated aluminium profiles should be unpacked straight away after unloading to avoid any contact with potential residual humidity within the package, and stored in a dry environment. In any case, untreated aluminium profiles should not be kept in contact of each others in a humid environment.

Do not store more than two pallets on top of each other.

In case of heavy wind, use straps.

11 - Maintenance

ArcoPlus® panels should be frequently cleaned with mild soapy water (neutral detergent) and thoroughly rinsed with clear water. Do not use warm water. Do not use organic solvents, abrasive or alkaline products.

12 – How to replace a damaged panel (with thermally broken profiles cod. 4597 e 4598 or with frontal opening profiles cod. 4140)

1. Remove the EPDM gasket 1169/b on top and low part of the cladding.
2. Remove the profile frontale edge turning it towards the inside.
3. Cut the damaged panel with a diamond cutting disc and remove the different parts.
4. Remove the panel on the right side, pushing it on the left and then pulling it down.
5. Create a "V-shape" with this panel and the new one. Then, insert them in the upper profile and press on the side joints to click the panels with the ones on the sides. Pull them down to put them in place.
6. Put back in place the AL drip edge, on the top and low part of the cladding.
7. Re-insert the EPDM gasket 1169/b between the gasket and the panels.

13 – Permissible loads

344X – Permissible loads on two supports.

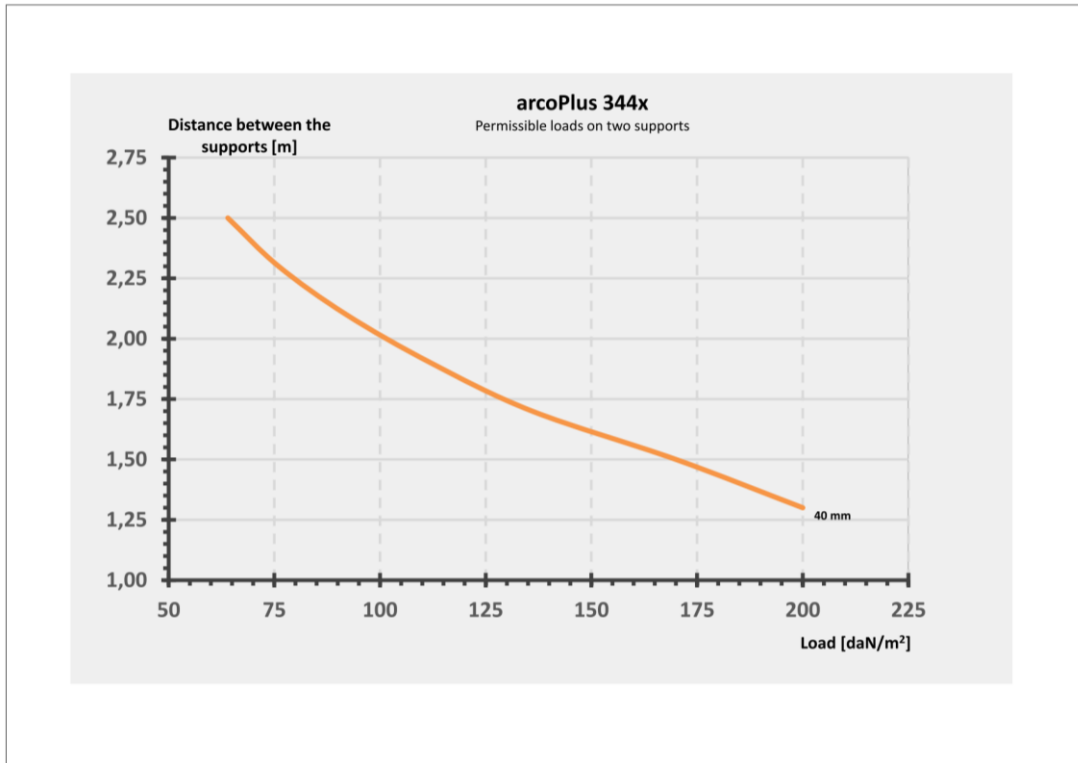

344X – Permissible loads on multiple supports.

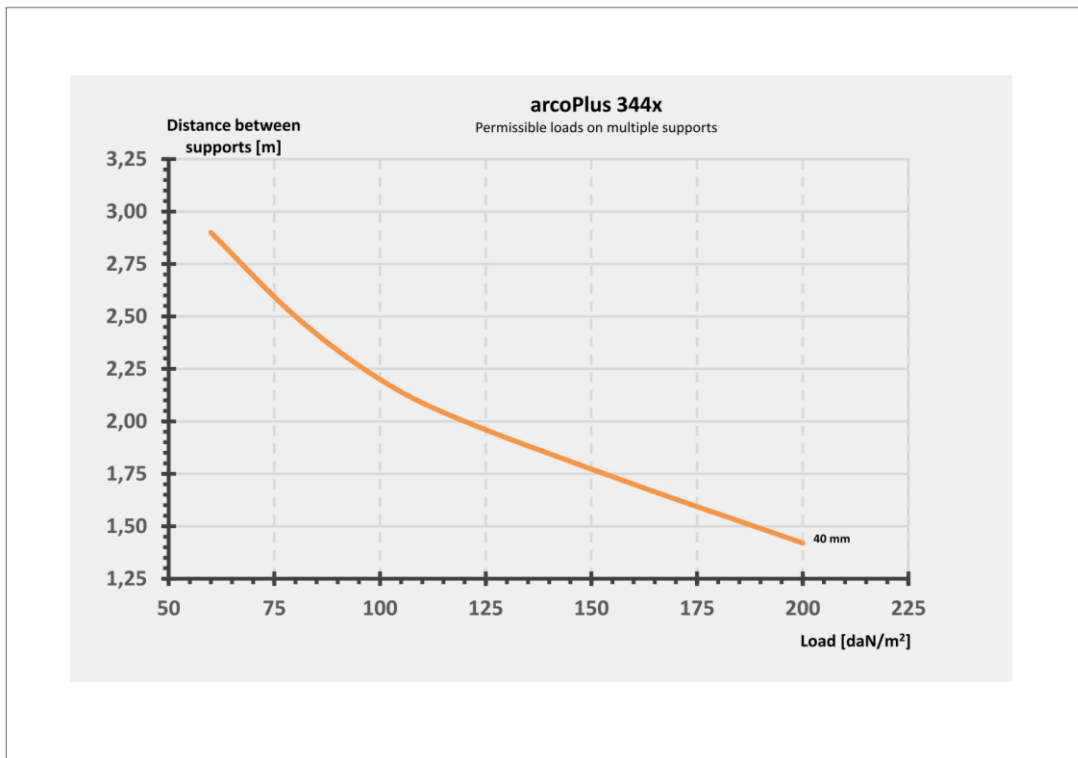

The permissible load for a specific distance between the supports can be calculated by interpolation between the x-axis value and the y-axis value.

347-547-549 – Permissible loads on two supports.

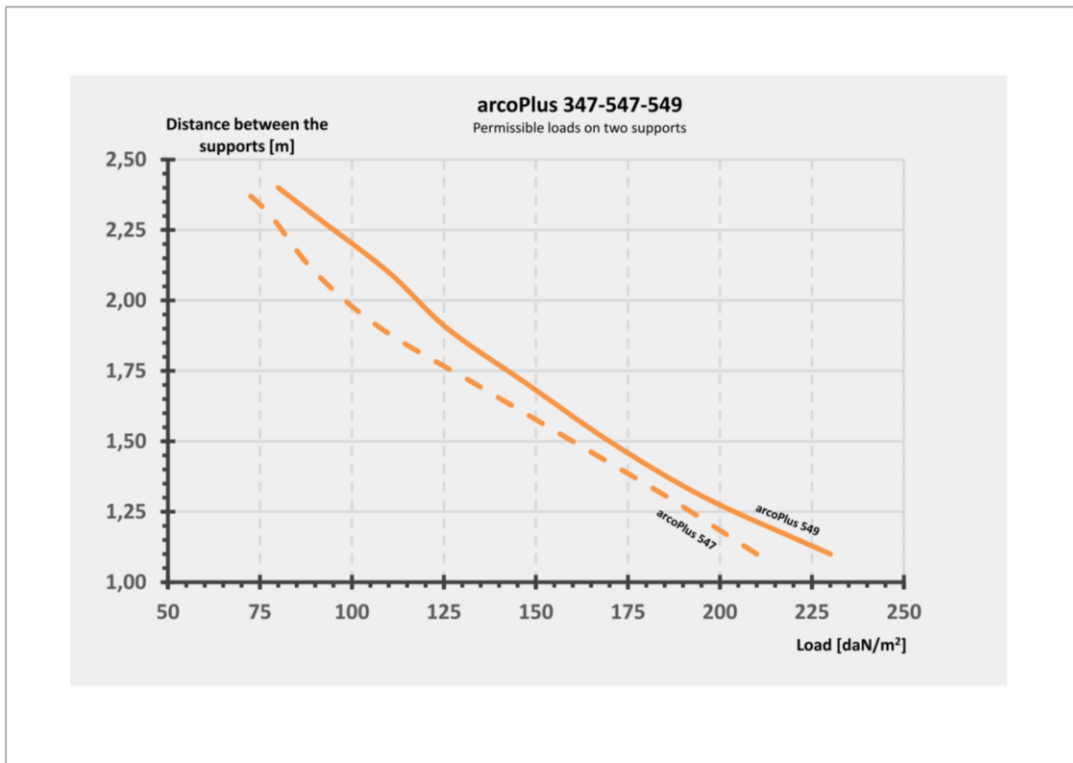

347-547-549 – Permissible loads on multiple supports.

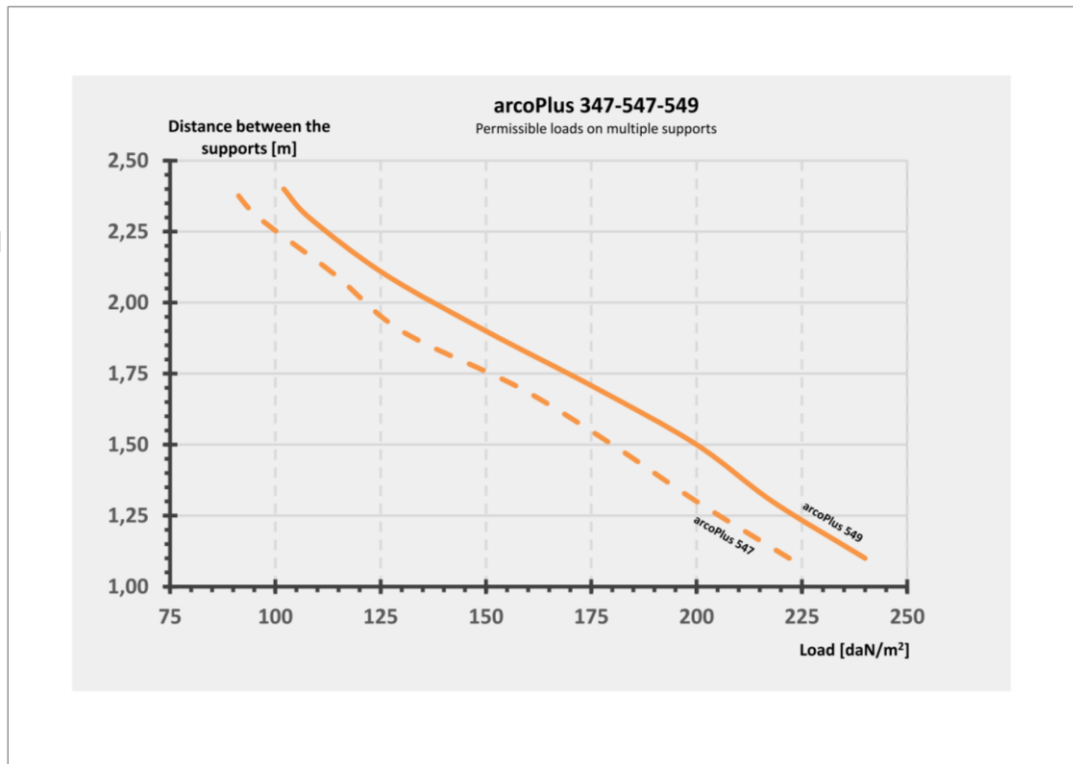

The permissible load for a specific distance between the supports can be calculated by interpolation between the x-axis value and the y-axis value.

Joint detail - arcoPlus 344X – 347 – 547 – 549

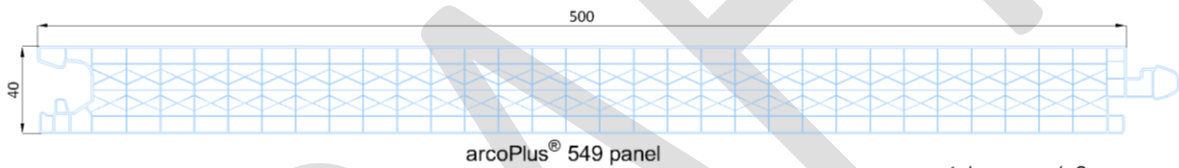
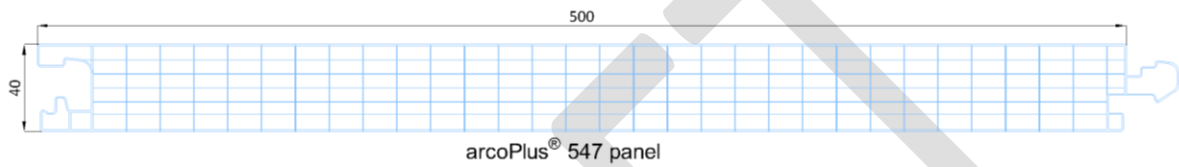
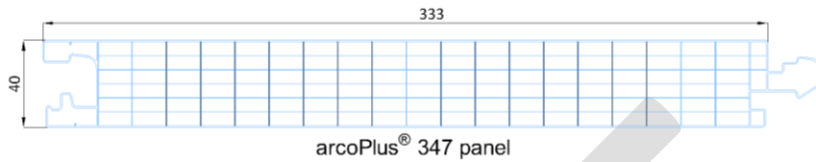
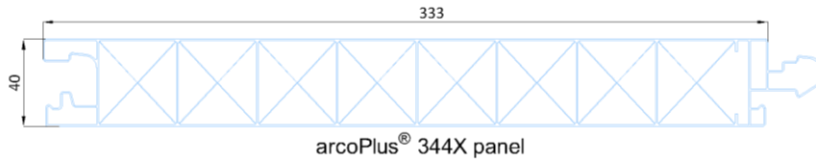

tolerance +/- 3mm

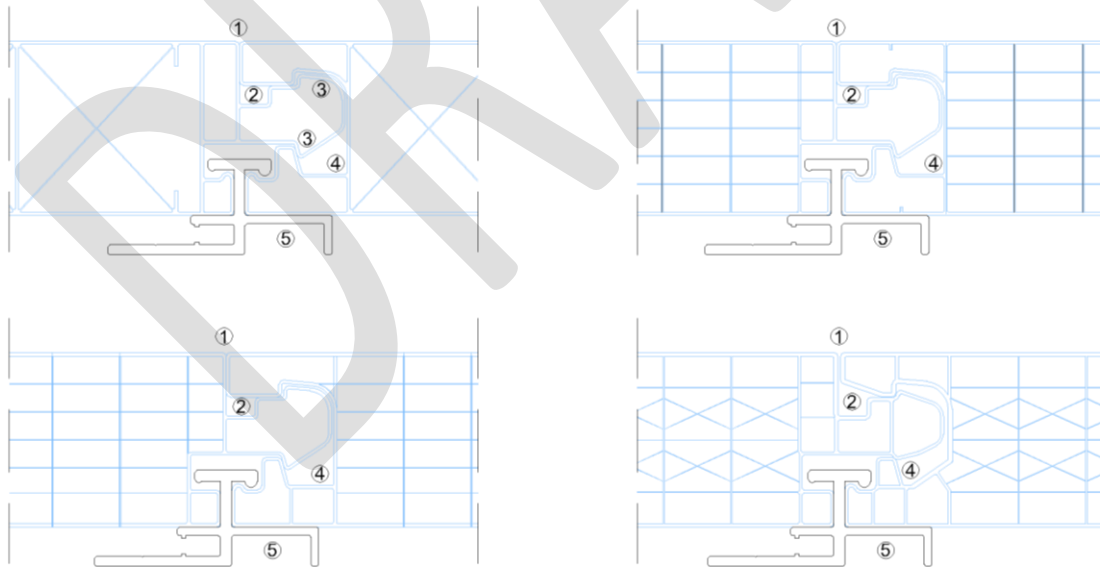

- 1 - Bring External UV protected faces into line
- 2 - Low pressure channel
- 3 - Adjacent panel assembly
- 4 - Important drainage channel
- 5 - Fixing bracket maintaining the 2 interlocking faces

AL profile and accessories

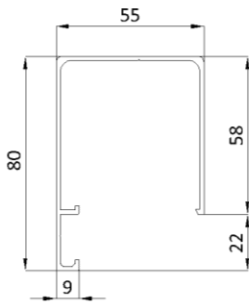

Upper/side AL profile
cod.4045

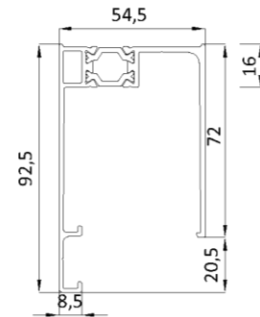

Upper/side AL TB profile
cod.4585



Gasket
cod.1169/b

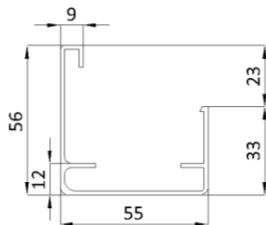

Base AL profile
cod.4047

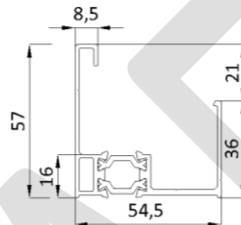

Base AL TB profile
cod.4587

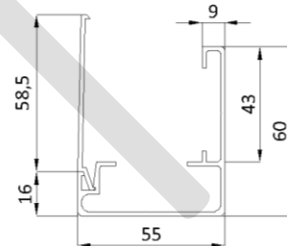

Base/upper/side AL
profile with frontal
opening cod.4140

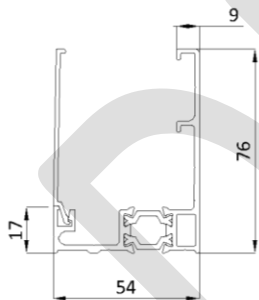

Base AL TB profile
cod.4597+4742

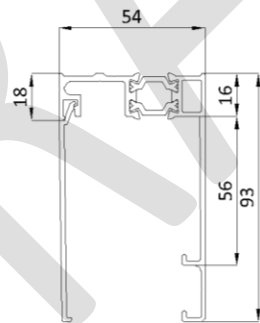

Upper/side AL TB profile
cod.4598+4743

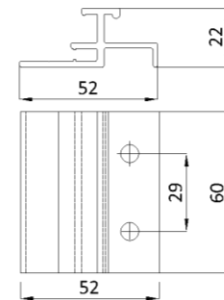

AL bracket
cod. 4050

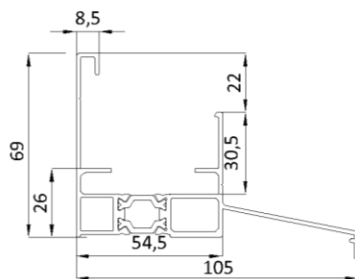

Base AL TB profile
with eave cod.4590

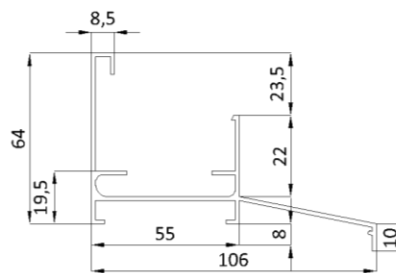

Base AL profile
with eave cod.4046

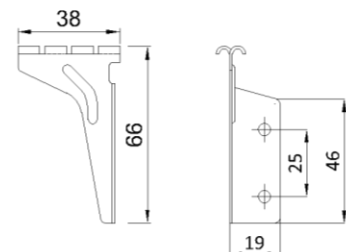

inox bracket cod.4052

Installation: upper profile detail

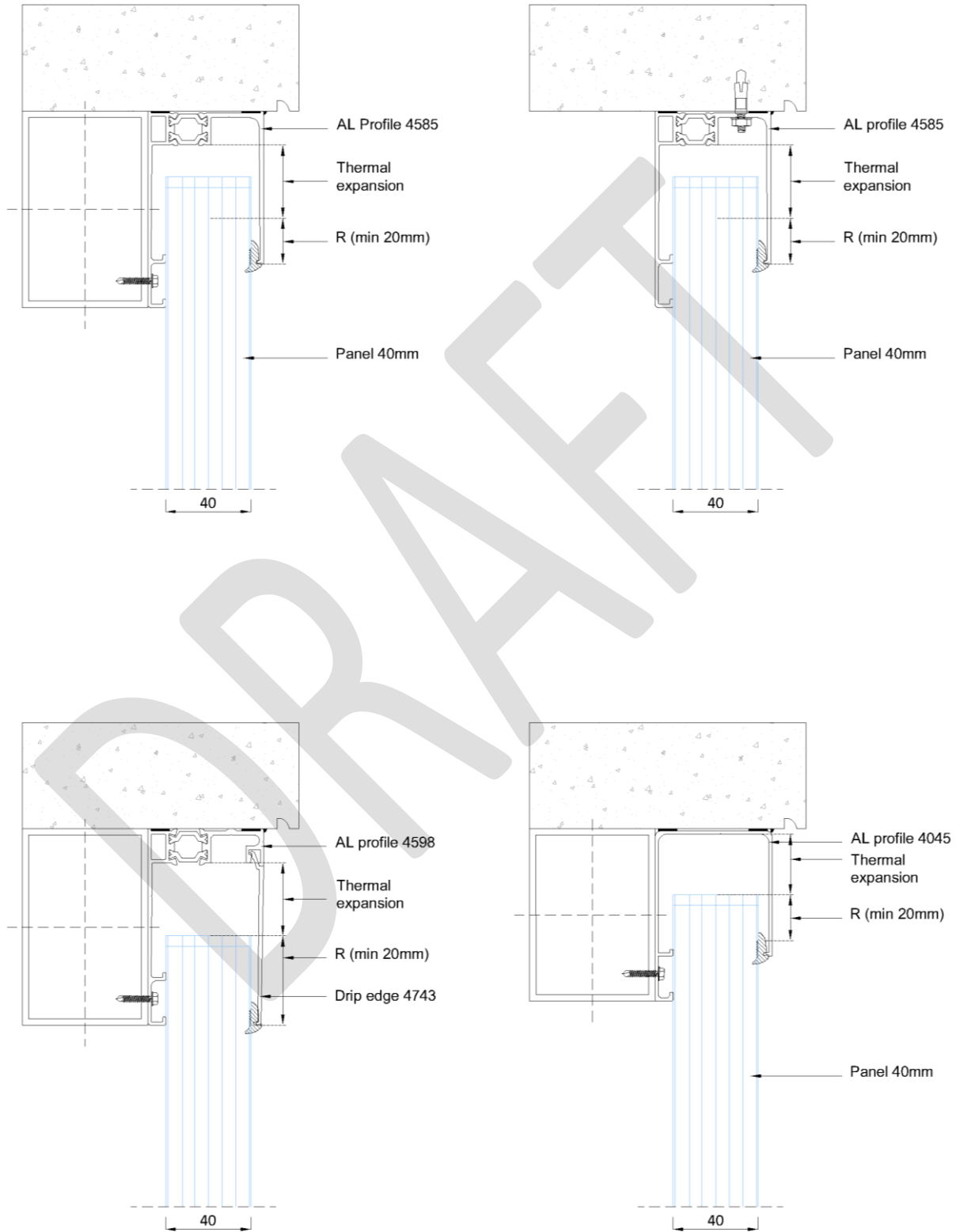

Installation: finishing of the AL profiles

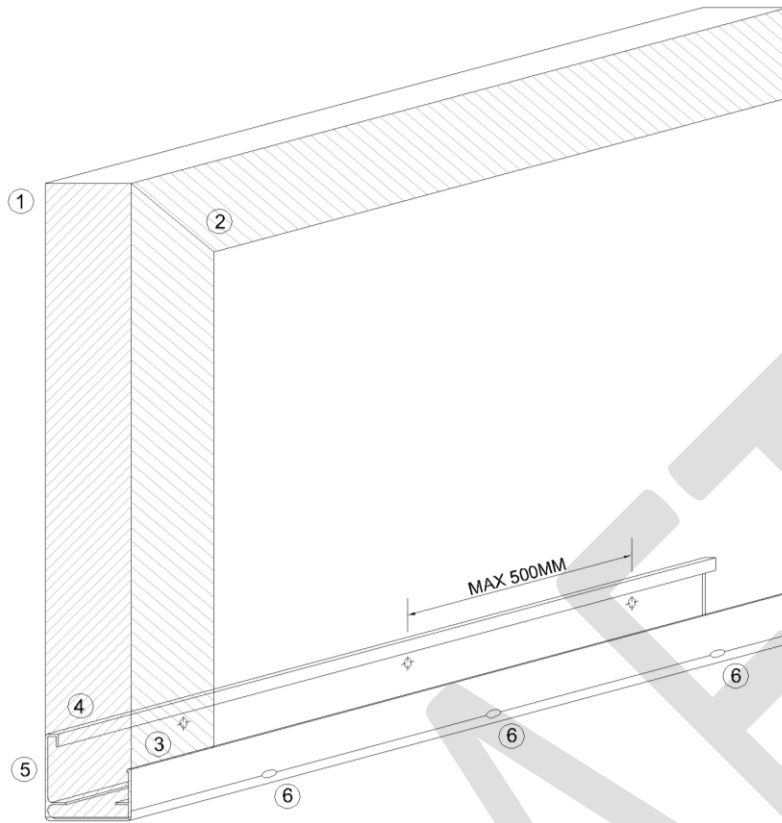

Upper part:
1 - Cut to 45° the upper and side profiles cod. 4045
2 - Seal the mitre cut with an elastomer

Base part:
3 - Shape the lateral profile front border as much as the length of the low profile front face
4 - Shape the back border following the same principle
5 - Seal the profile mitre cuts and junctions with an elastomer mastic
6 - Check the drainage of the low profile (hole diam. 8 mm below or on the frontal part every 333 mm)

Installation of the panels

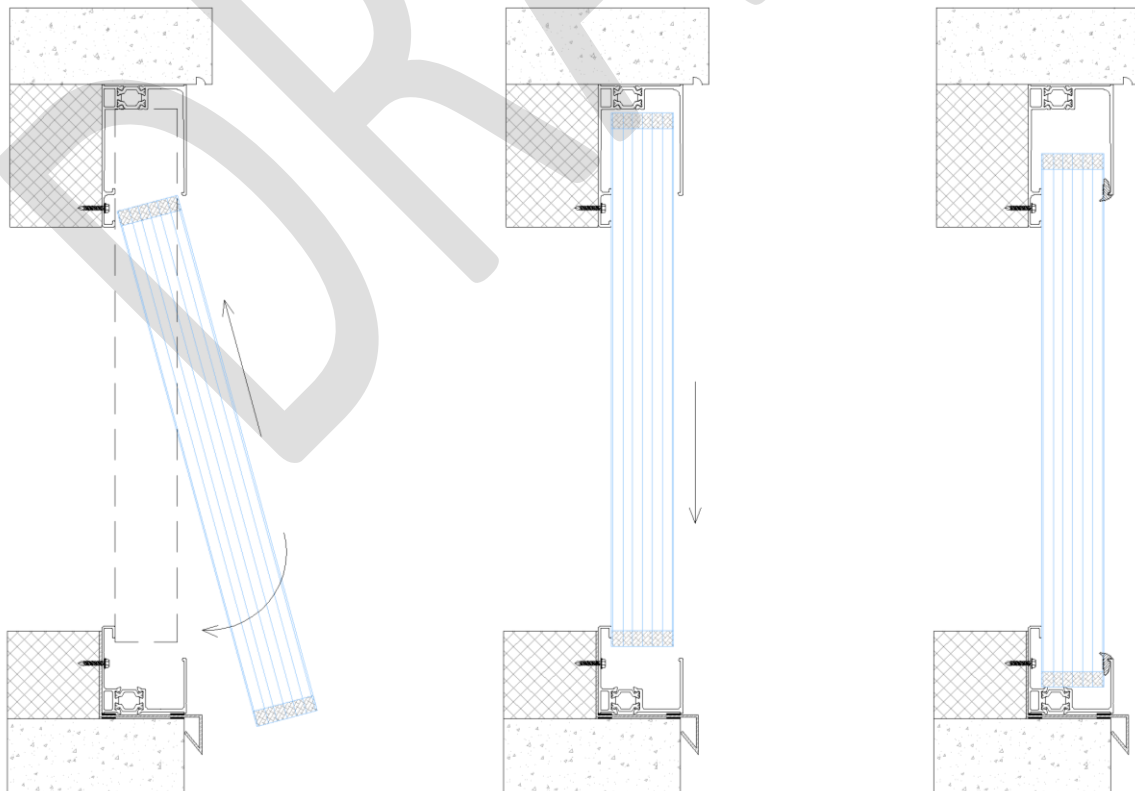

Installation of the AL brackets cod. 4050

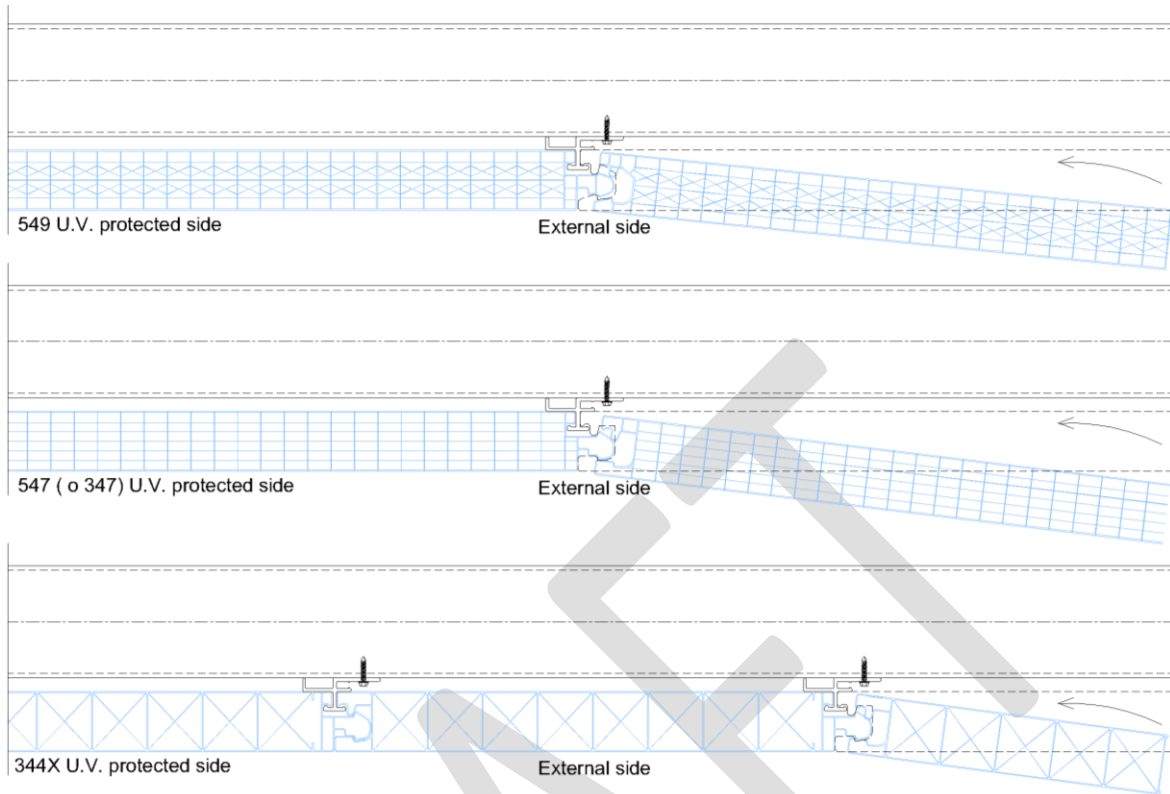

Installation of the last panel

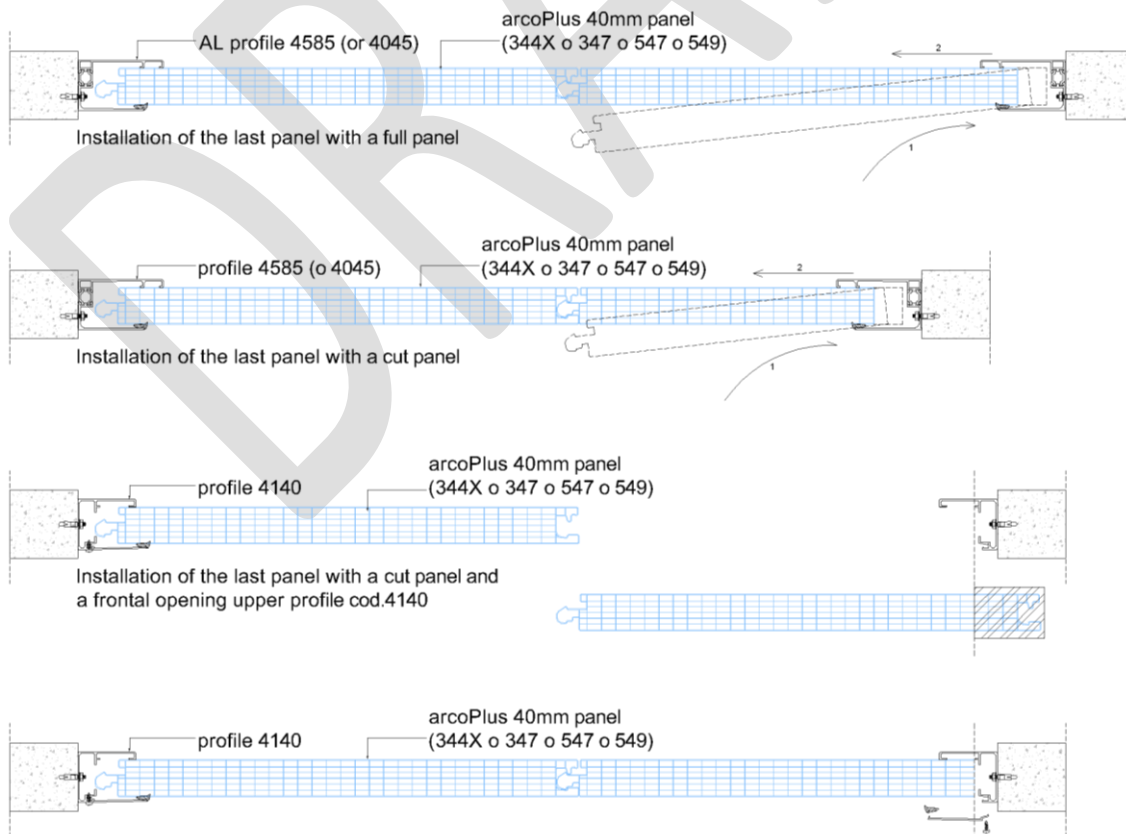

Vertical installation: fitting between two supports with thermally broken profiles

cod. 4587 e 4585

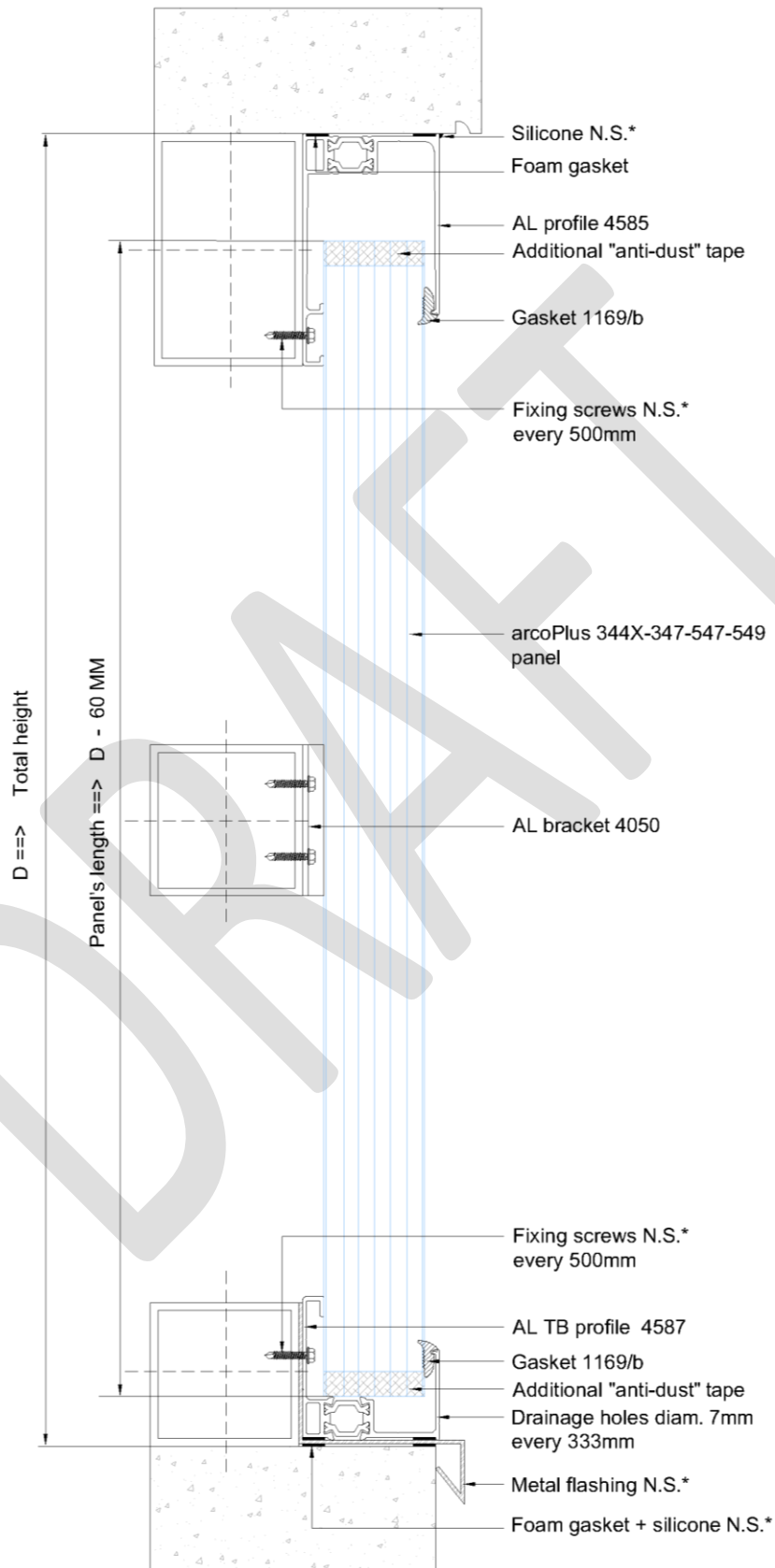

N.S.* = Not supplied by Gallina

Vertical installation: fitting between two supports with thermally broken profiles

cod. 4590 e 4585

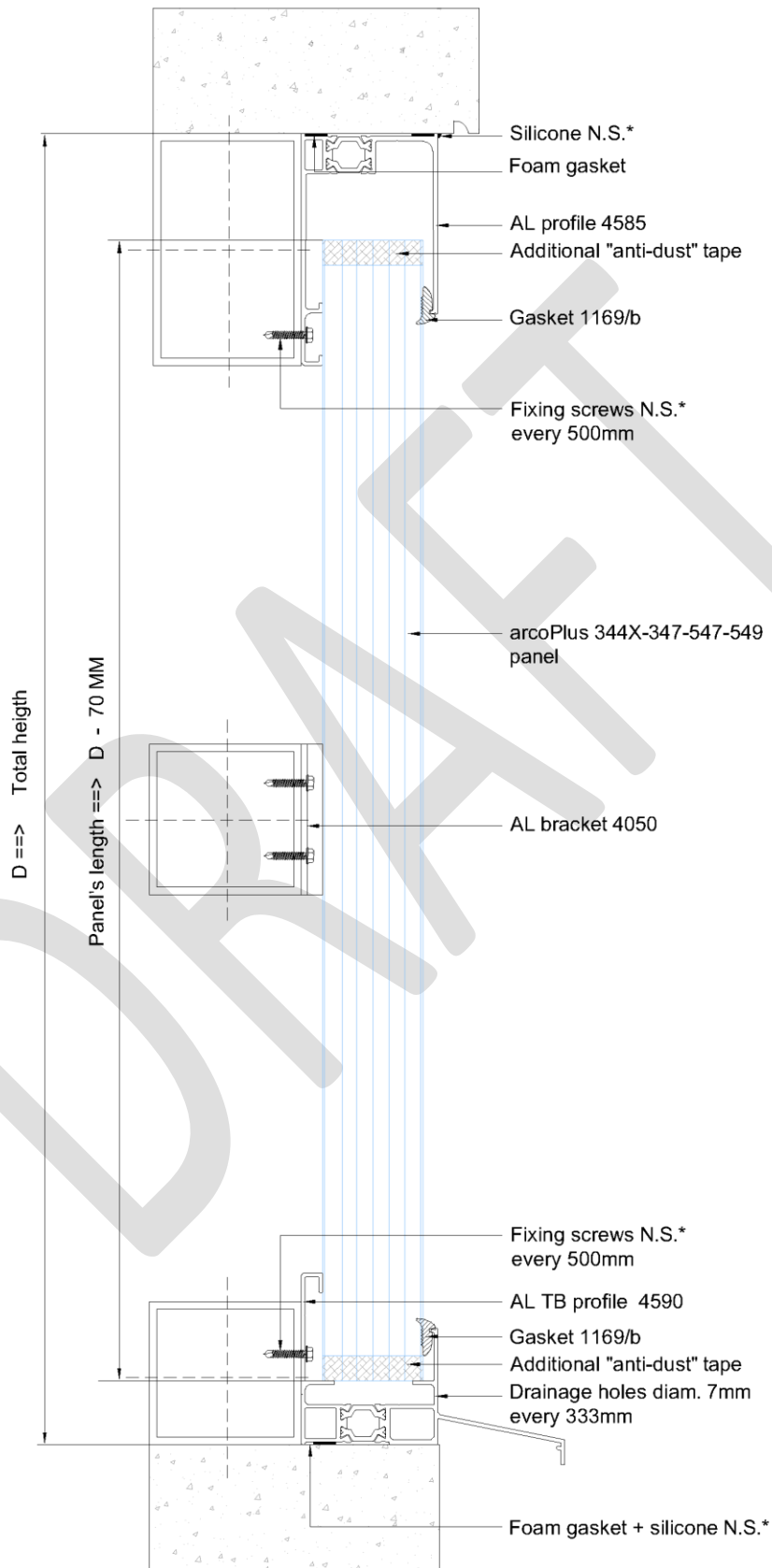

N.S.* = Not supplied by Gallina

Vertical installation: front of the building installation with thermally broken profiles

cod. 4587 e 4585

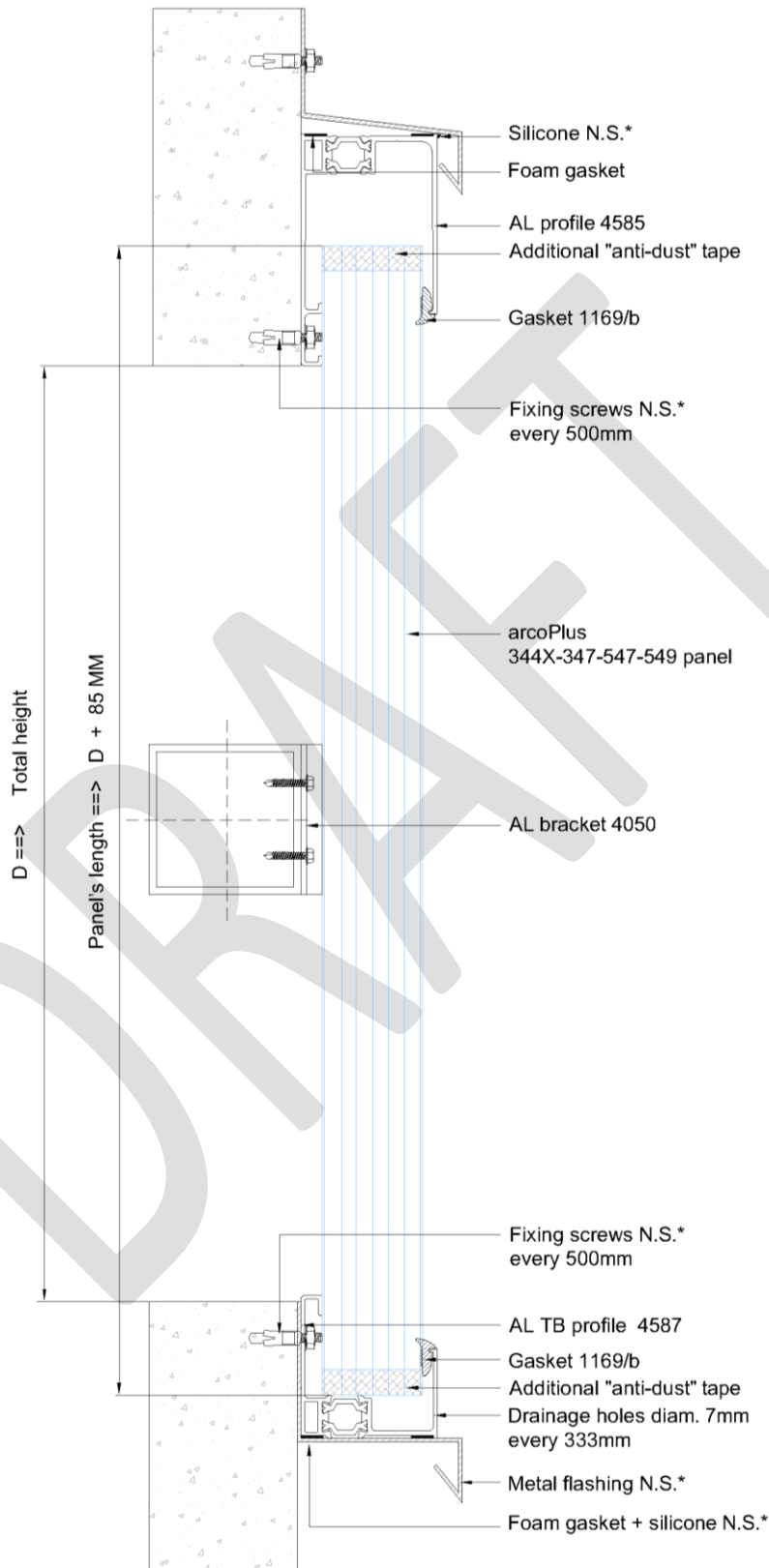

N.S.* = Not supplied by Gallina

Vertical installation: front of the building installation with thermally broken profiles

cod. 4590 e 4585

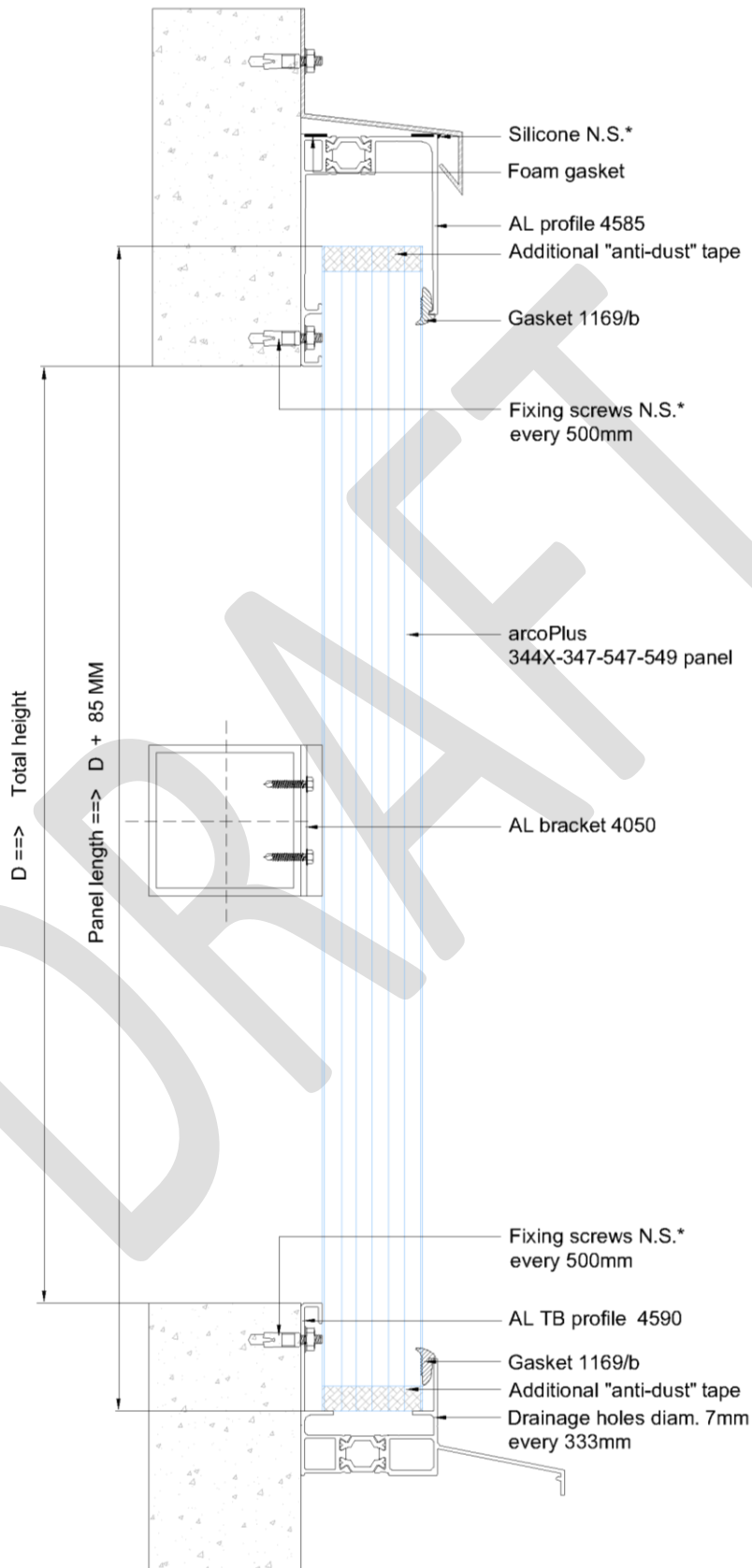

N.S.* = Not supplied by Gallina

Inclined installation: fitting between two supports with thermally broken profiles
cod. 4587 e 4585

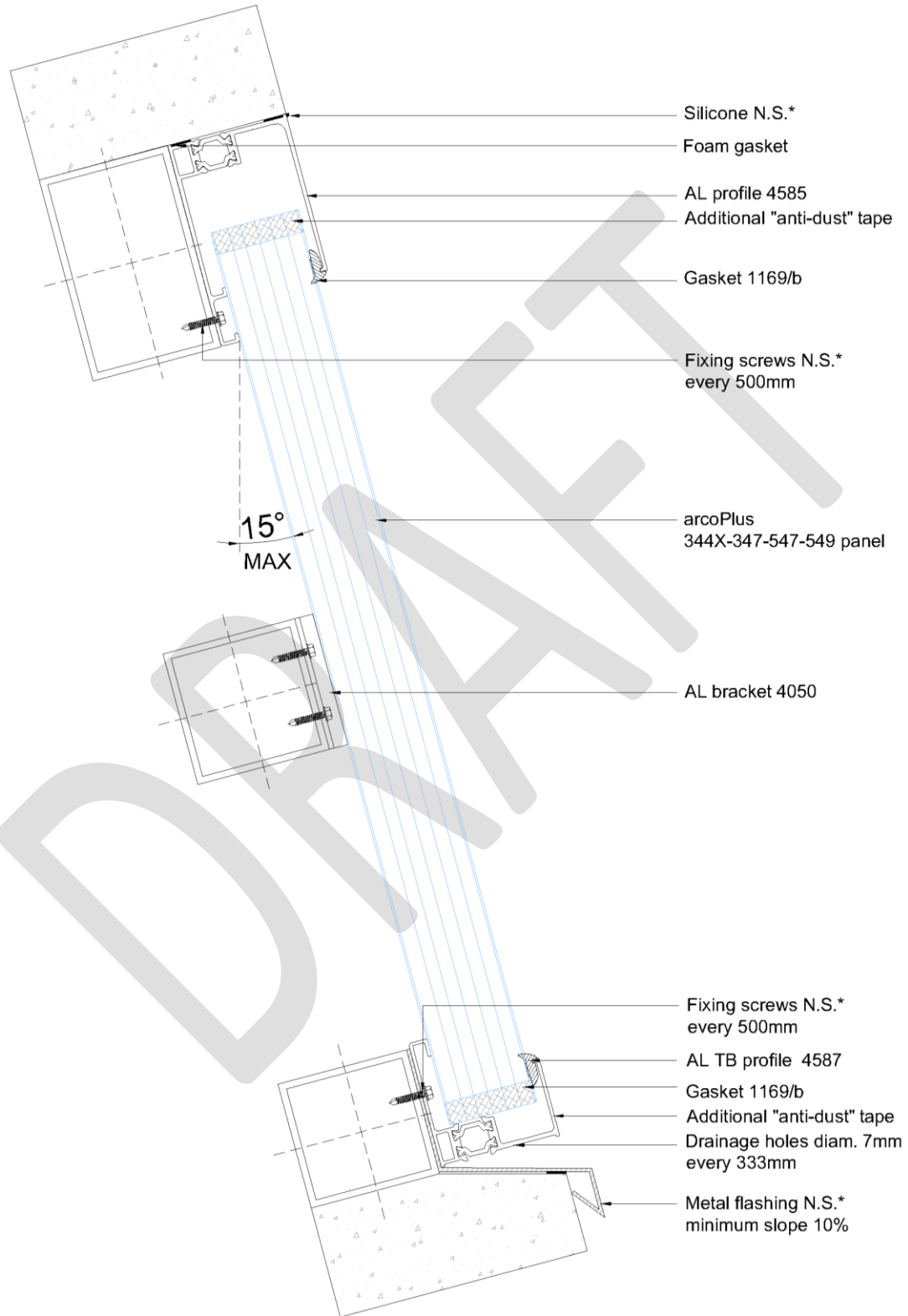

N.S.* = Not supplied by Gallina

Junction of superposed cladding with TB profiles cod. 4587 e 4585

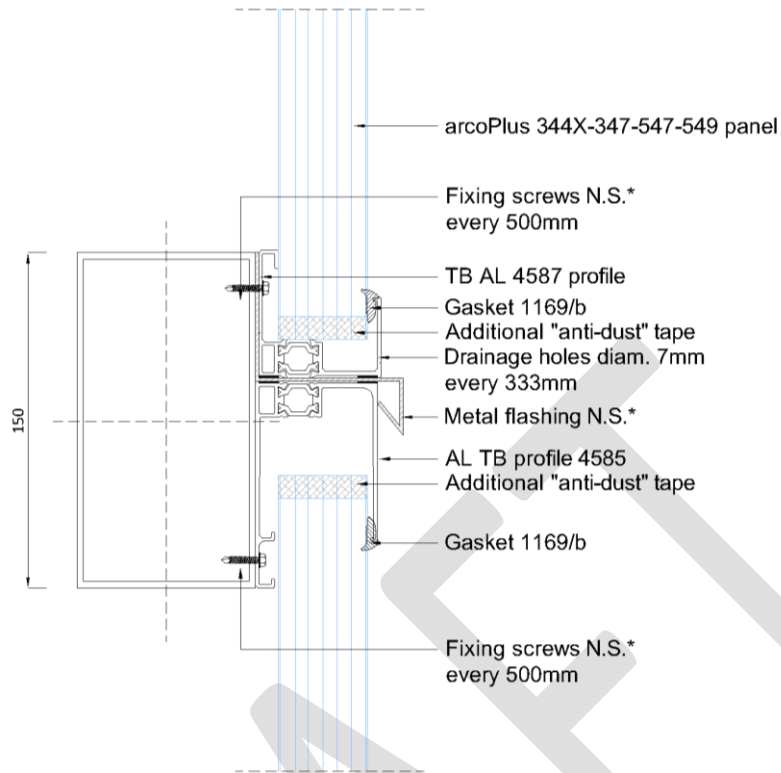

Detail of the angle with TB profiles cod. 4585

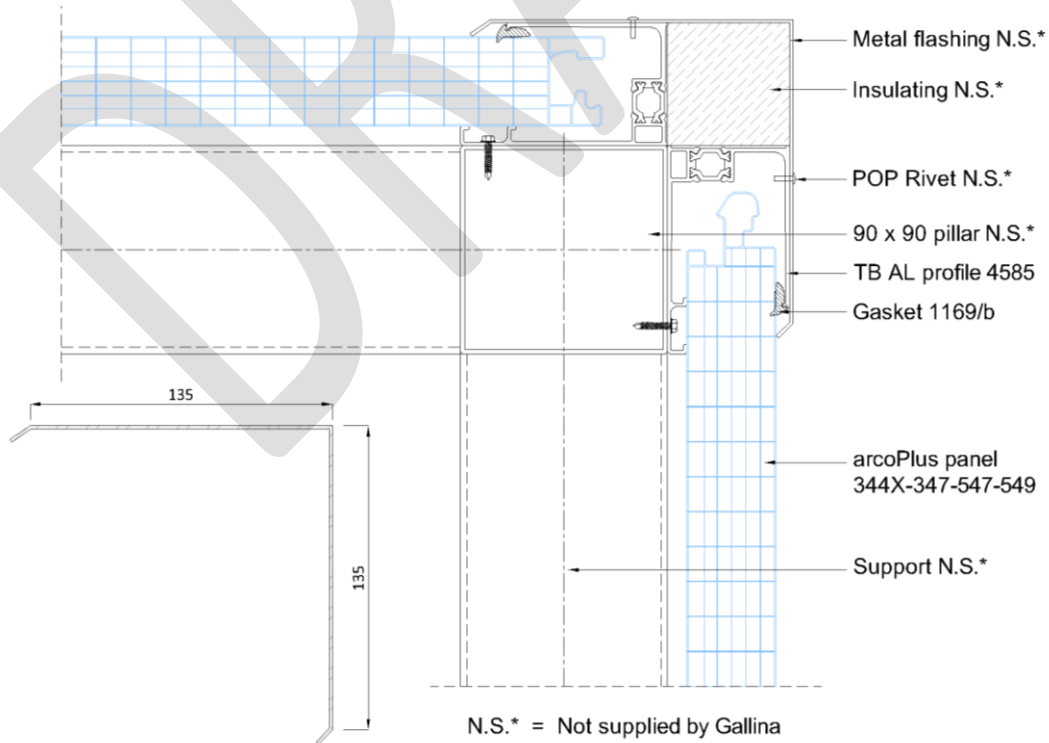

Expansion joint's detail with TB profile cod. 4585

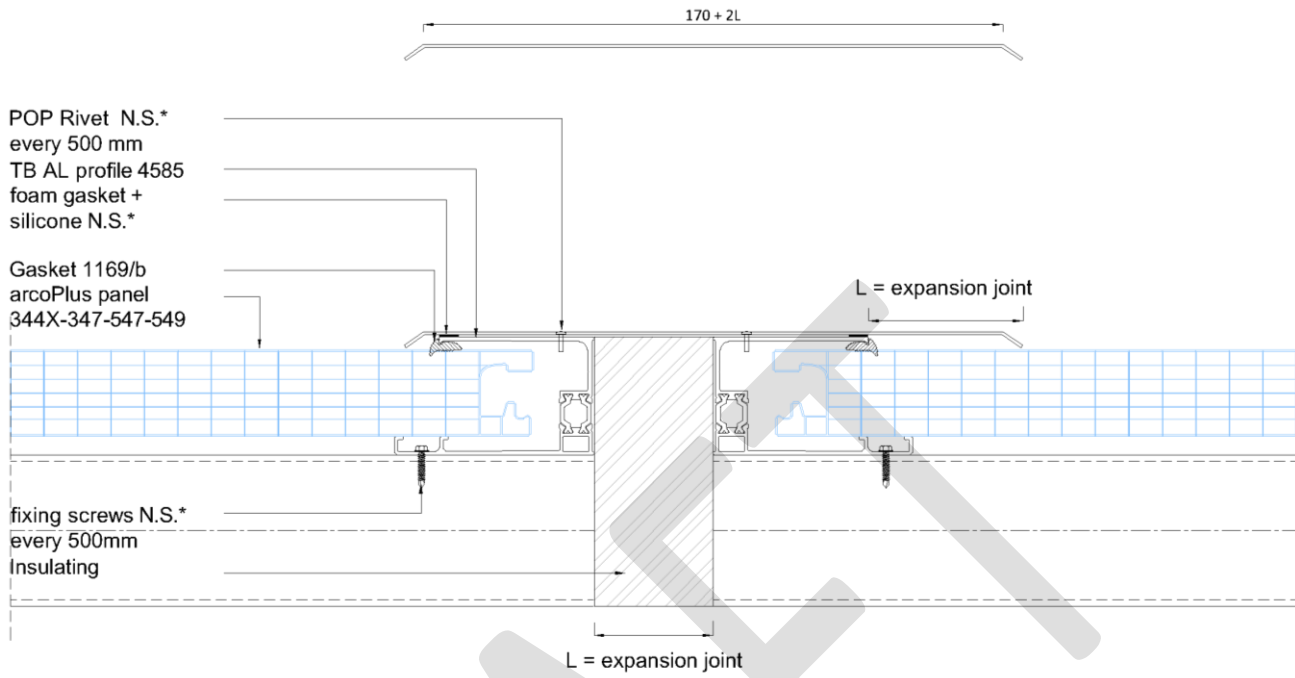

Vertical installation: fitting between two supports with profiles cod. 4047 e 4045

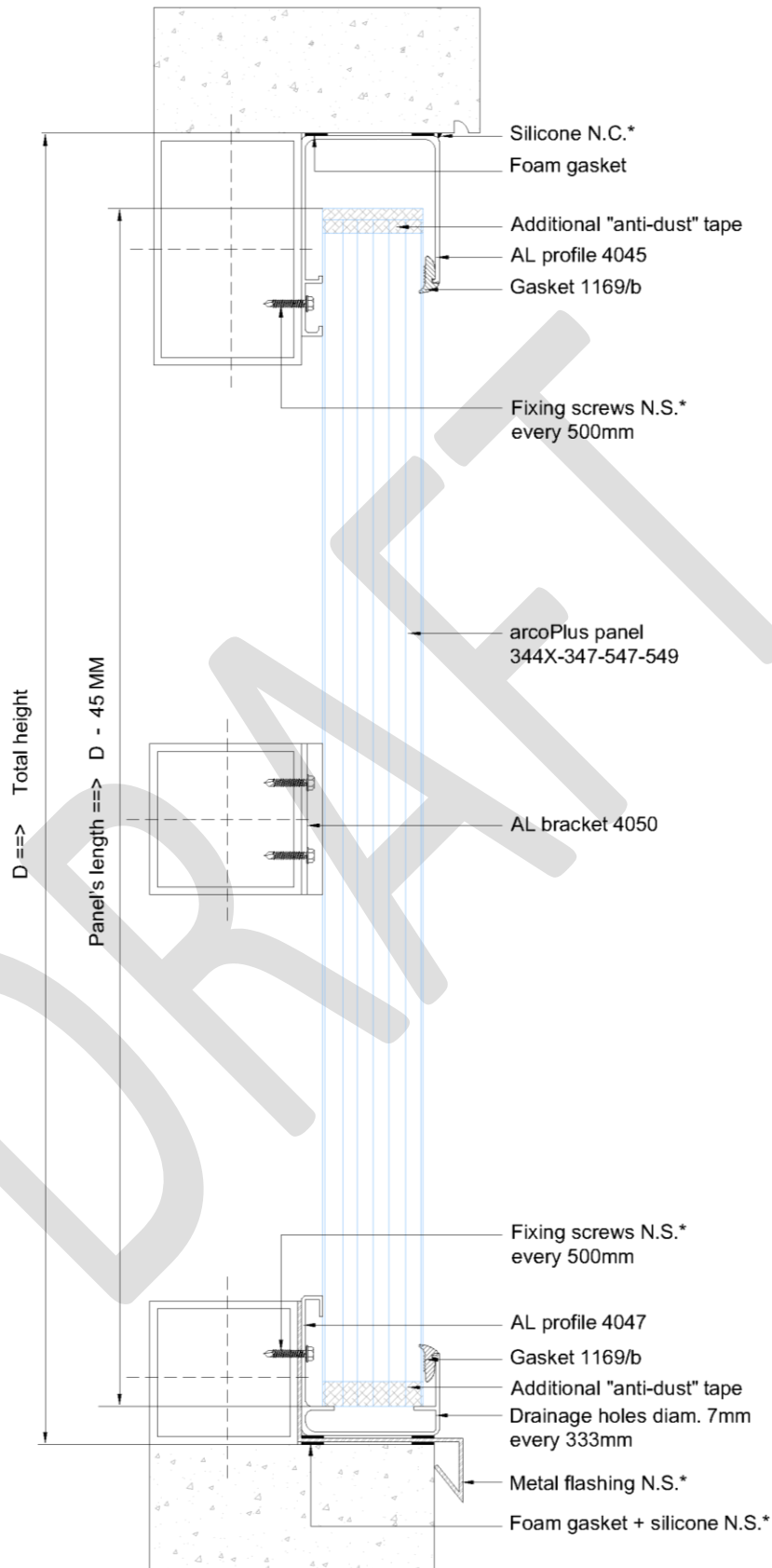

N.S.* = Not supplied by Gallina

Vertical installation: fitting between two supports with profiles cod. 4046 e 4045

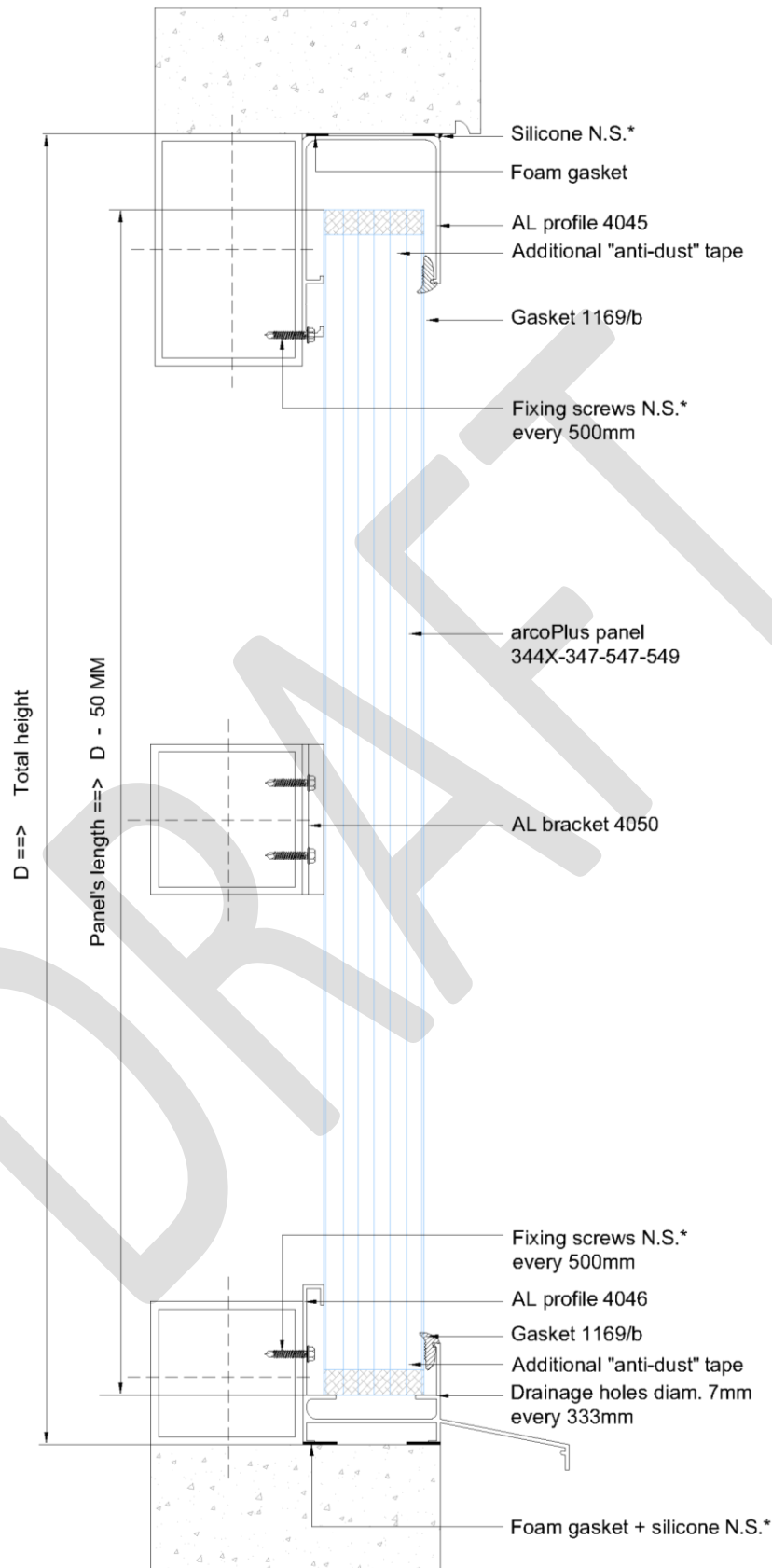

N.S.* = Not supplied by Gallina

Vertical installation: front of the building installation with profiles cod. 4047 e 4045

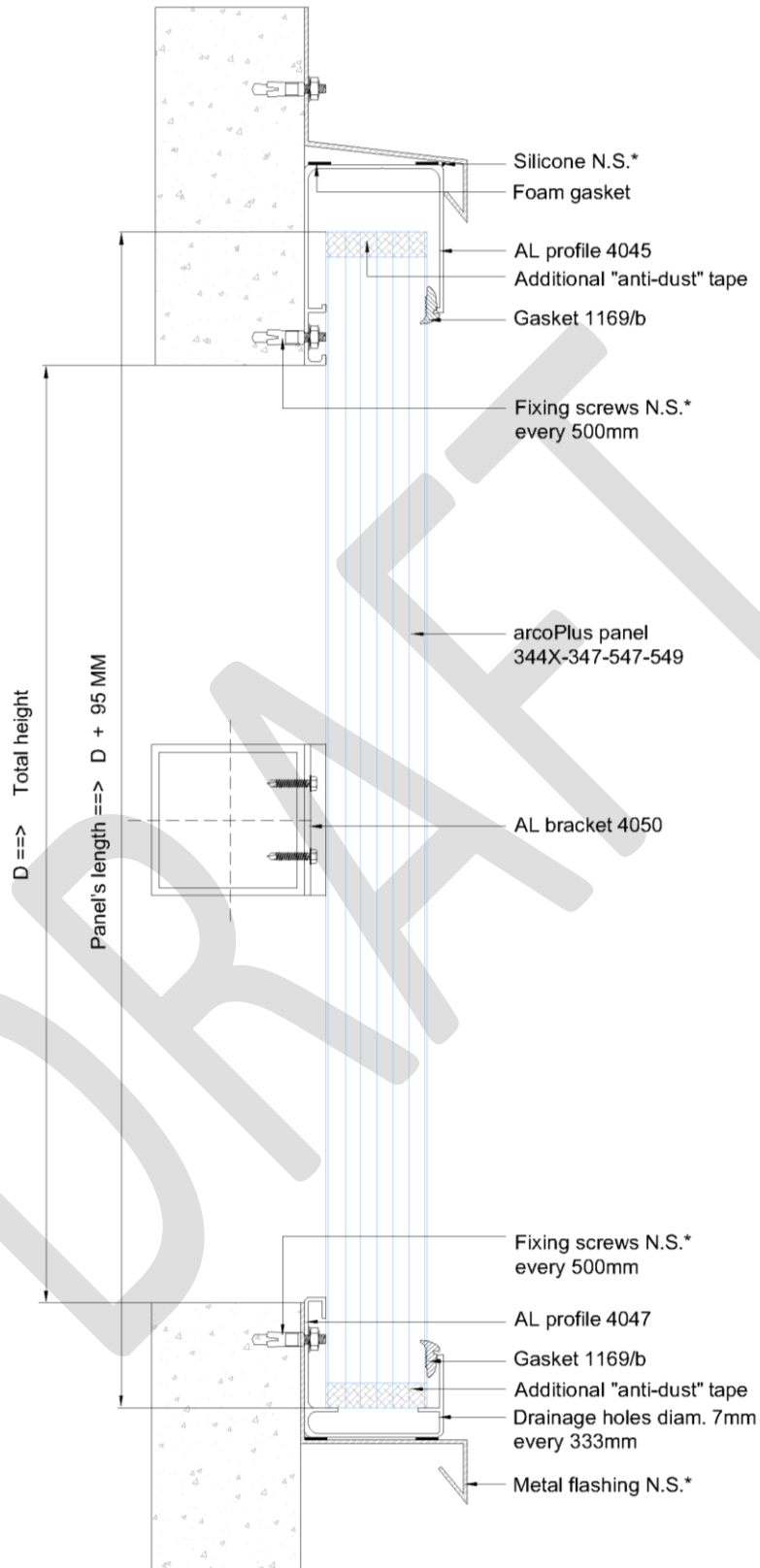

N.S.* = Not supplied by Gallina

Vertical installation: front of the building installation with profiles cod. 4046 e 4045

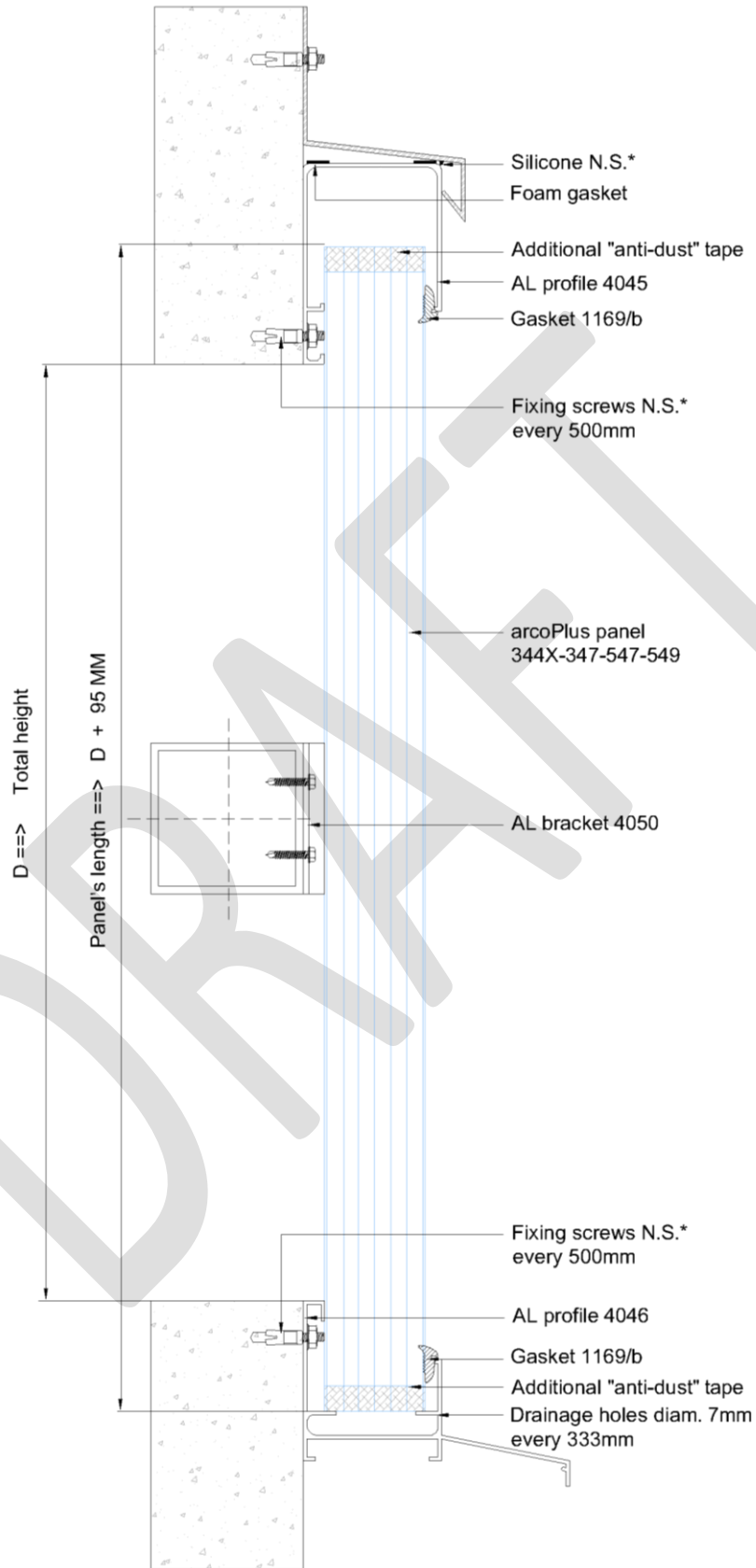

N.S.* = Not supplied by Gallina

Inclined installation: fitting between two supports with profiles cod. 4047 e 4045

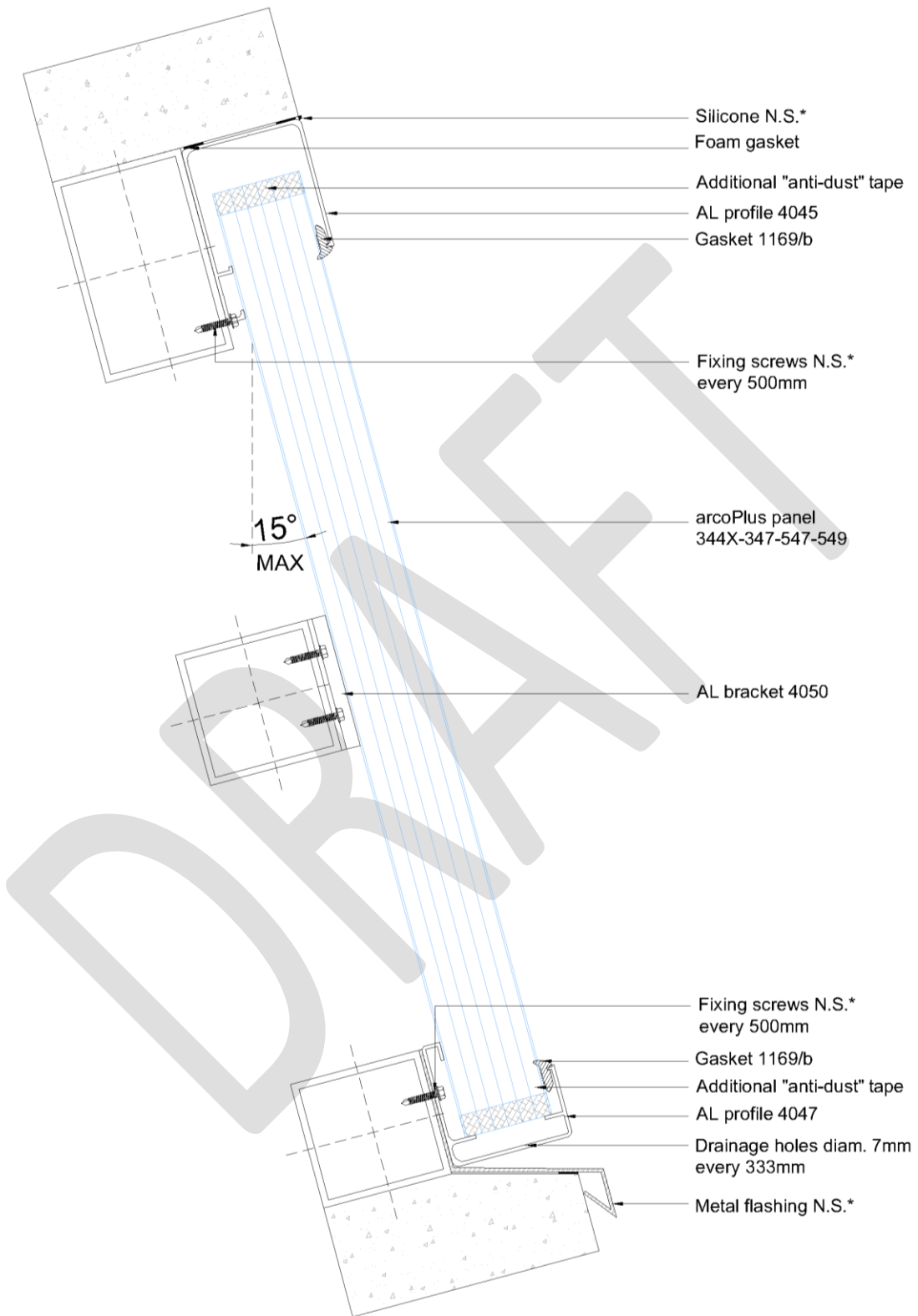

N.S.* = Not supplied by Gallina

Junction of superposed cladding with profiles cod. 4047 e 4045

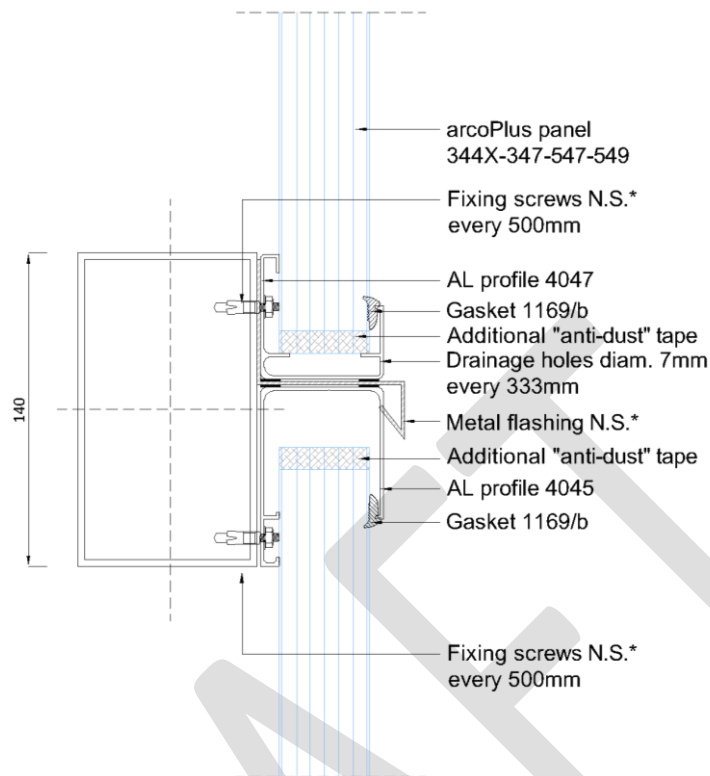

Angle detail with standard profile cod. 4045

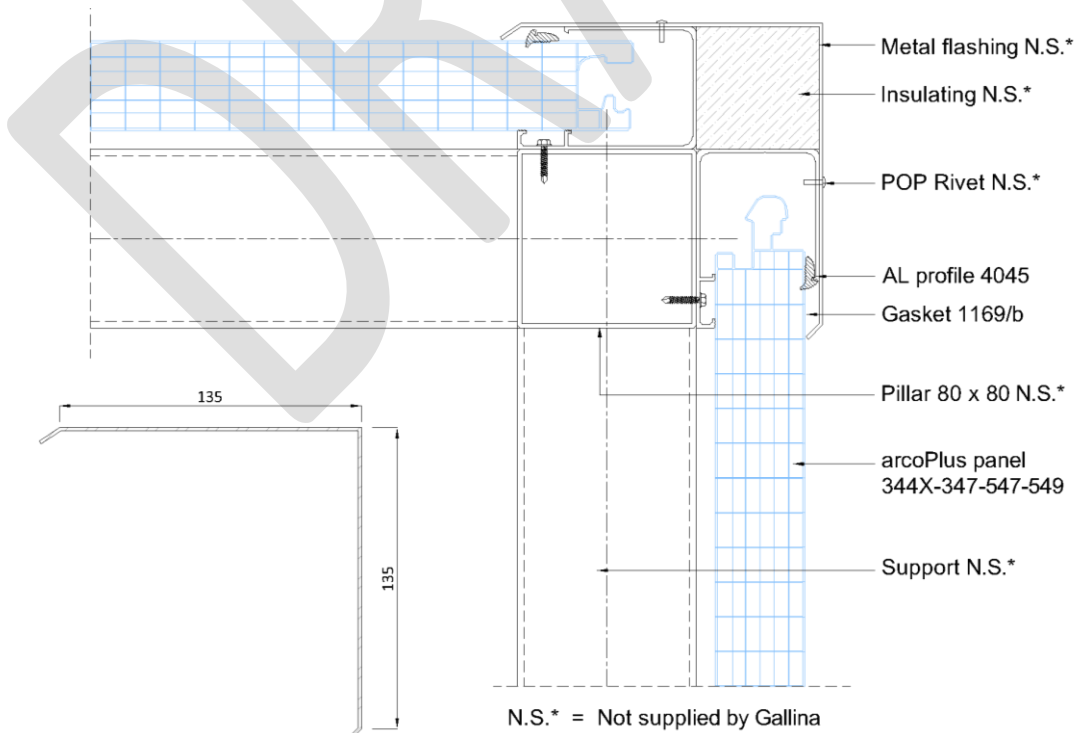

Expansion joint's detail with standard profile cod.4045

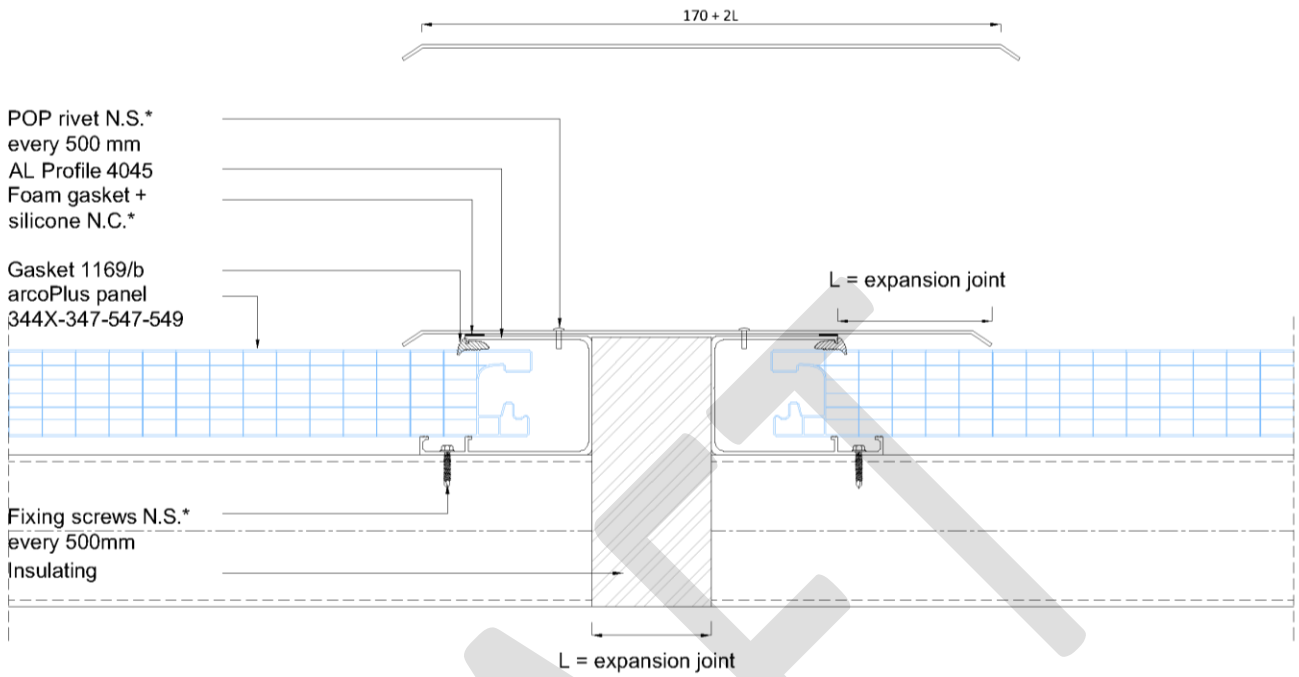

DRAFT

Vertical installation: fitting between two supports for “grand longueur”
with profiles cod. 4047 & 4140 + 4275

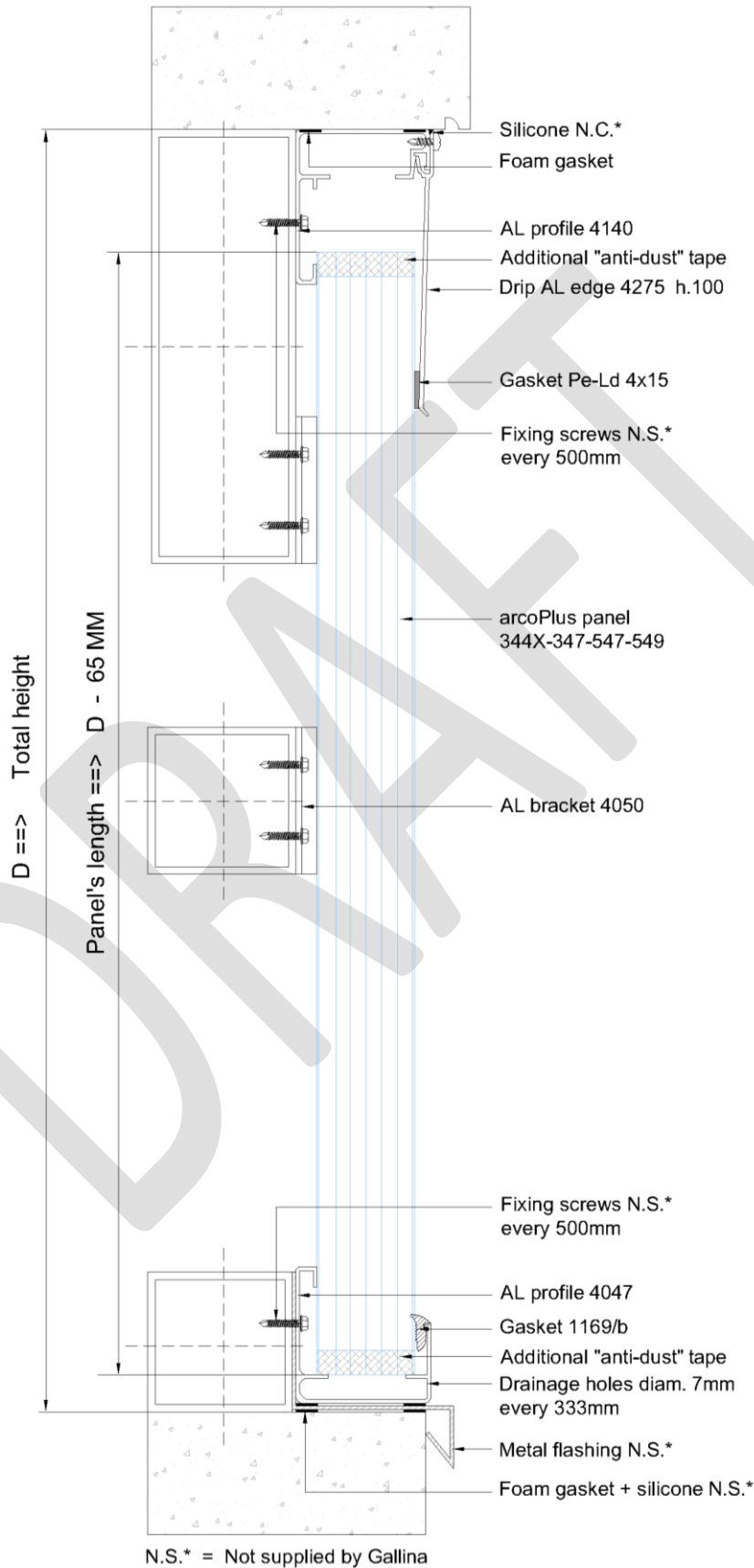

Vertical installation: front of the building installation for "grand longueur"
cod. 4047 & 4140 + 4275

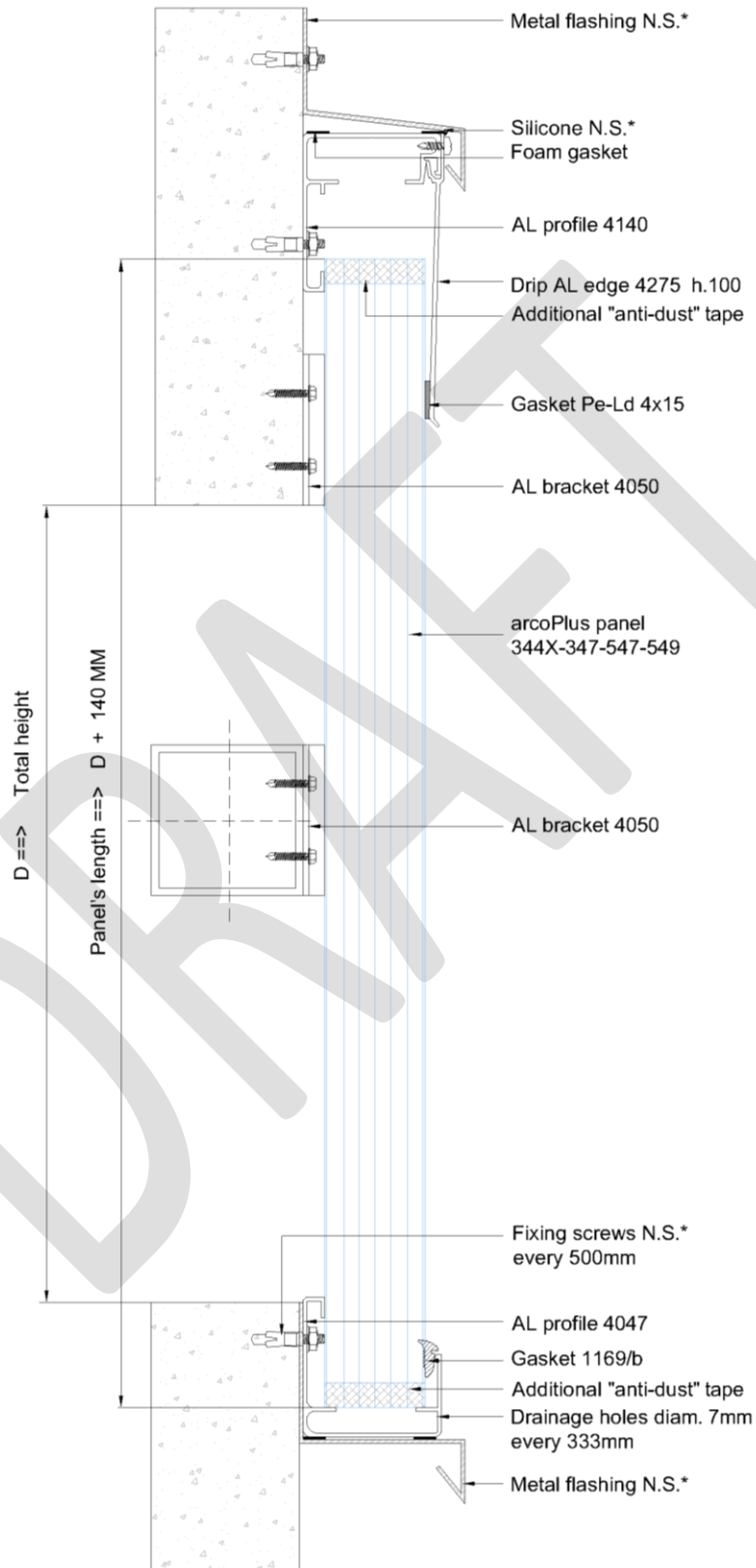

N.S.* = Not supplied by Gallina

Vertical installation: fitting between two supports with frontal opening profiles

cod. 4140

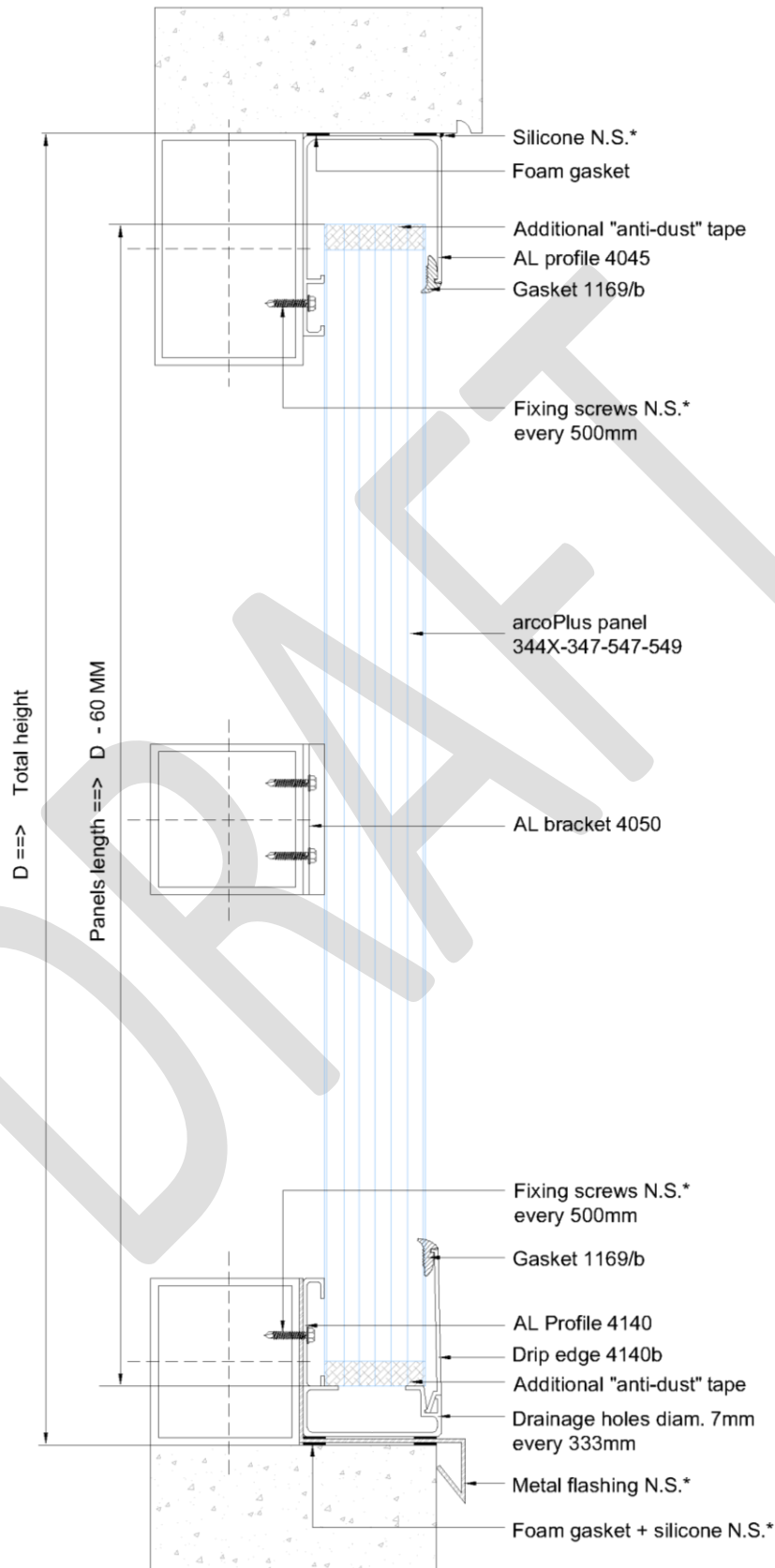

N.S.* = Not supplied by Gallina

Vertical installation: front of the building installation with frontal opening profiles

cod. 4140

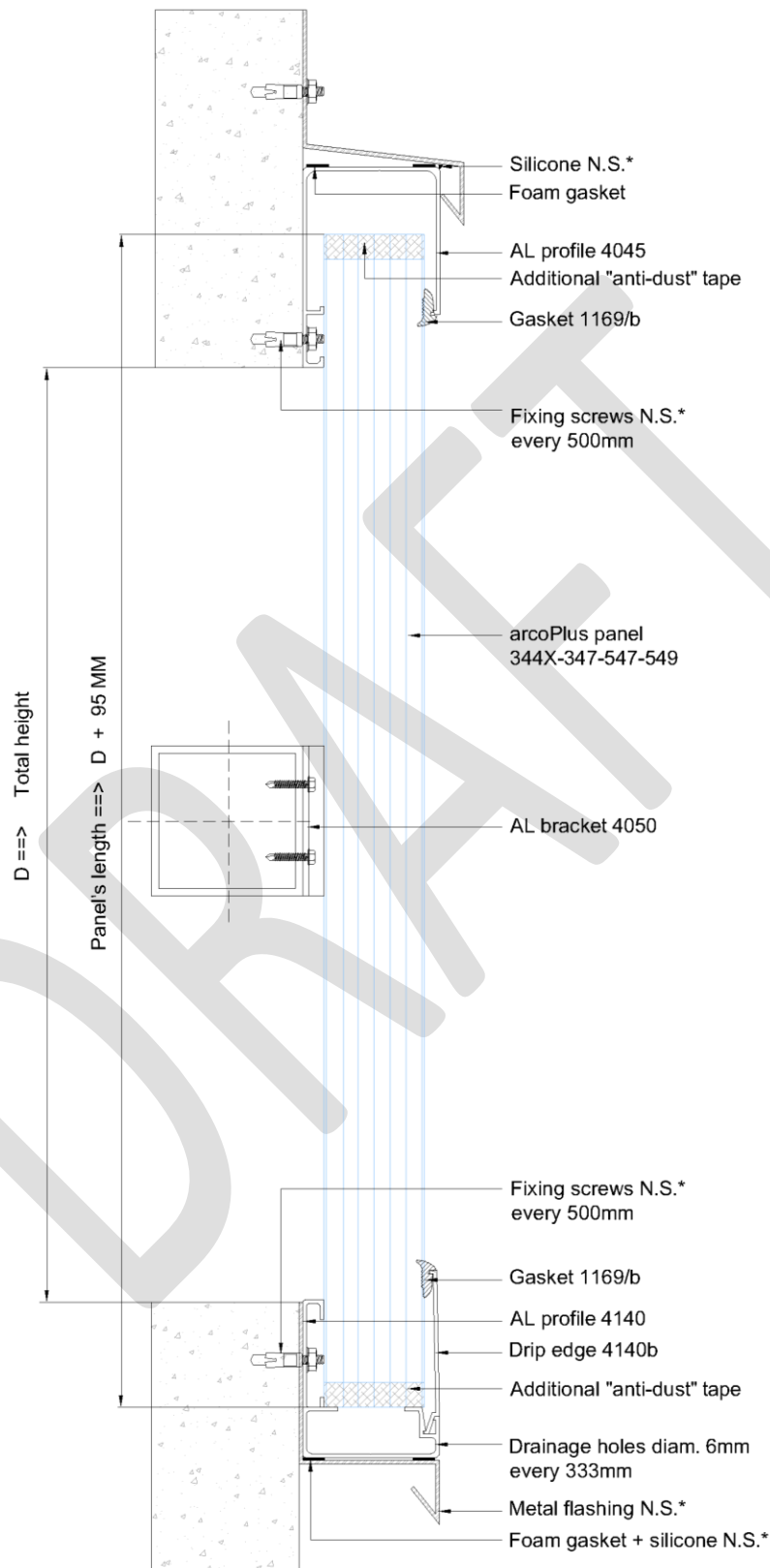

N.S.* = Not supplied by Gallina

Vertical installation: fitting between two supports with TB profiles cod. 4597 e 4598

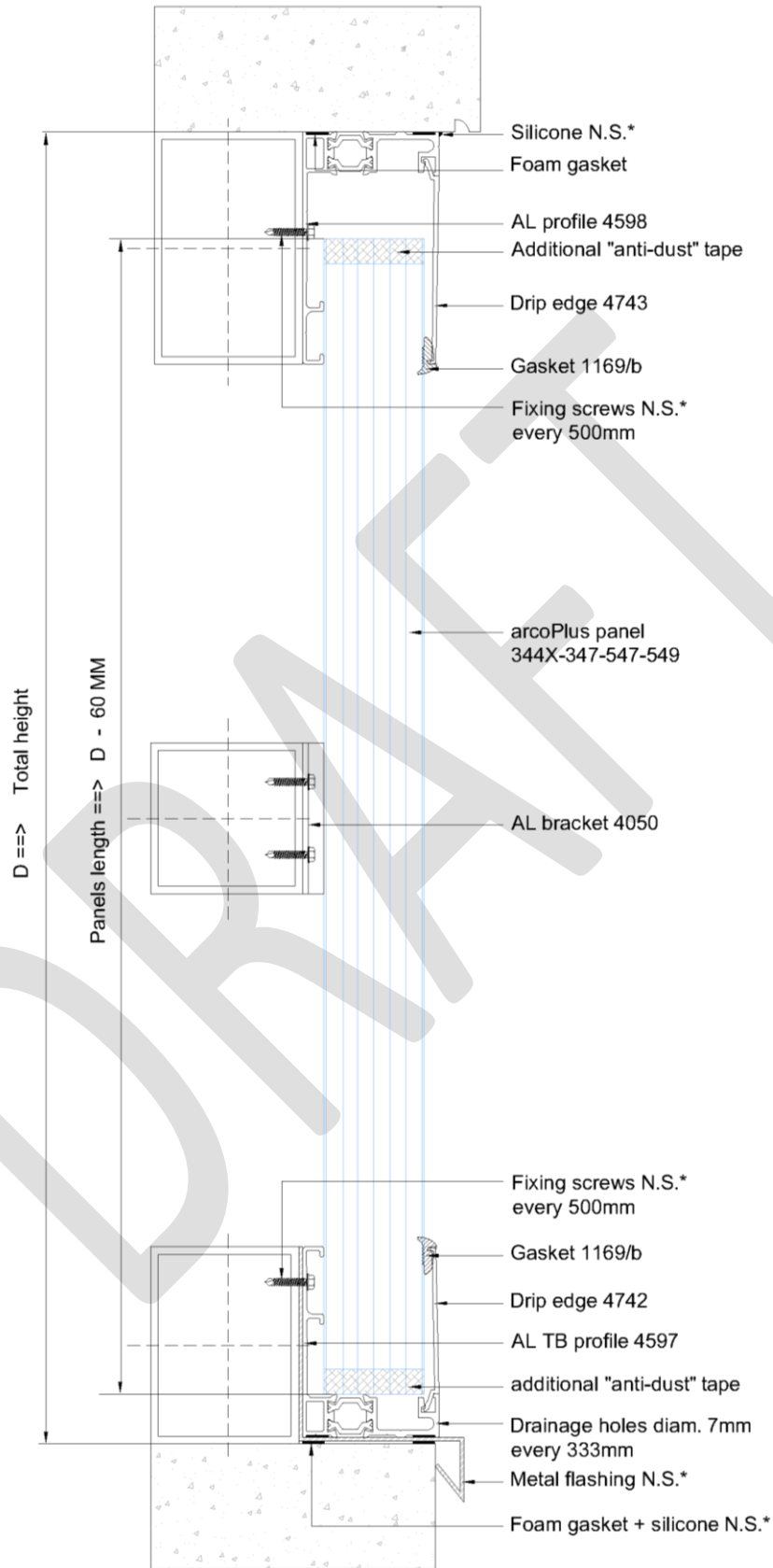

N.S.* = Not supplied by Gallina

Vertical installation: front of the building installation with TB profiles

cod. 4597 e 4598

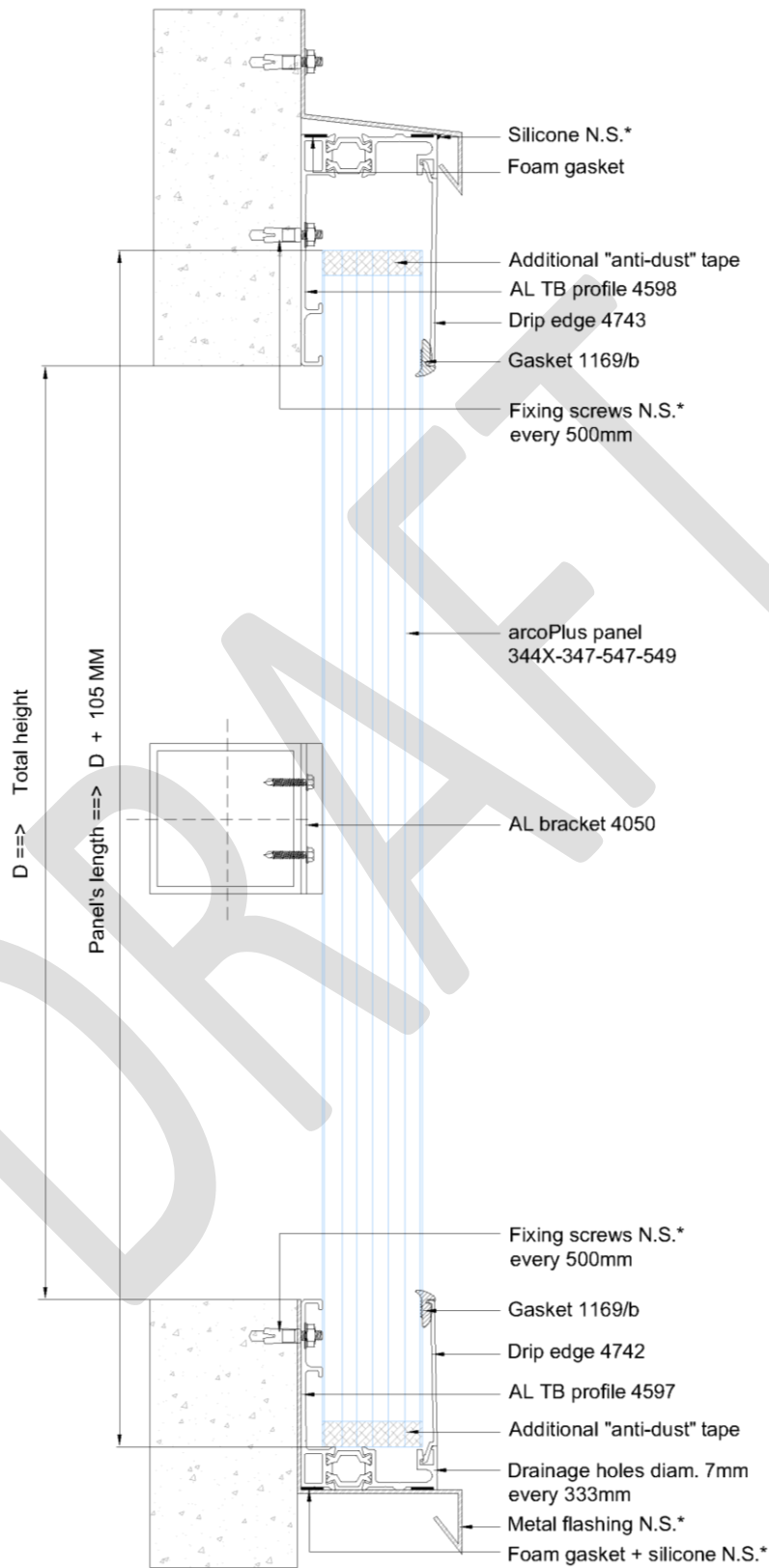

N.S.* = Not supplied by Gallina

Vertical installation: fitting between two supports for "grand longueur"
cod. 4597 & 4598 + 4275

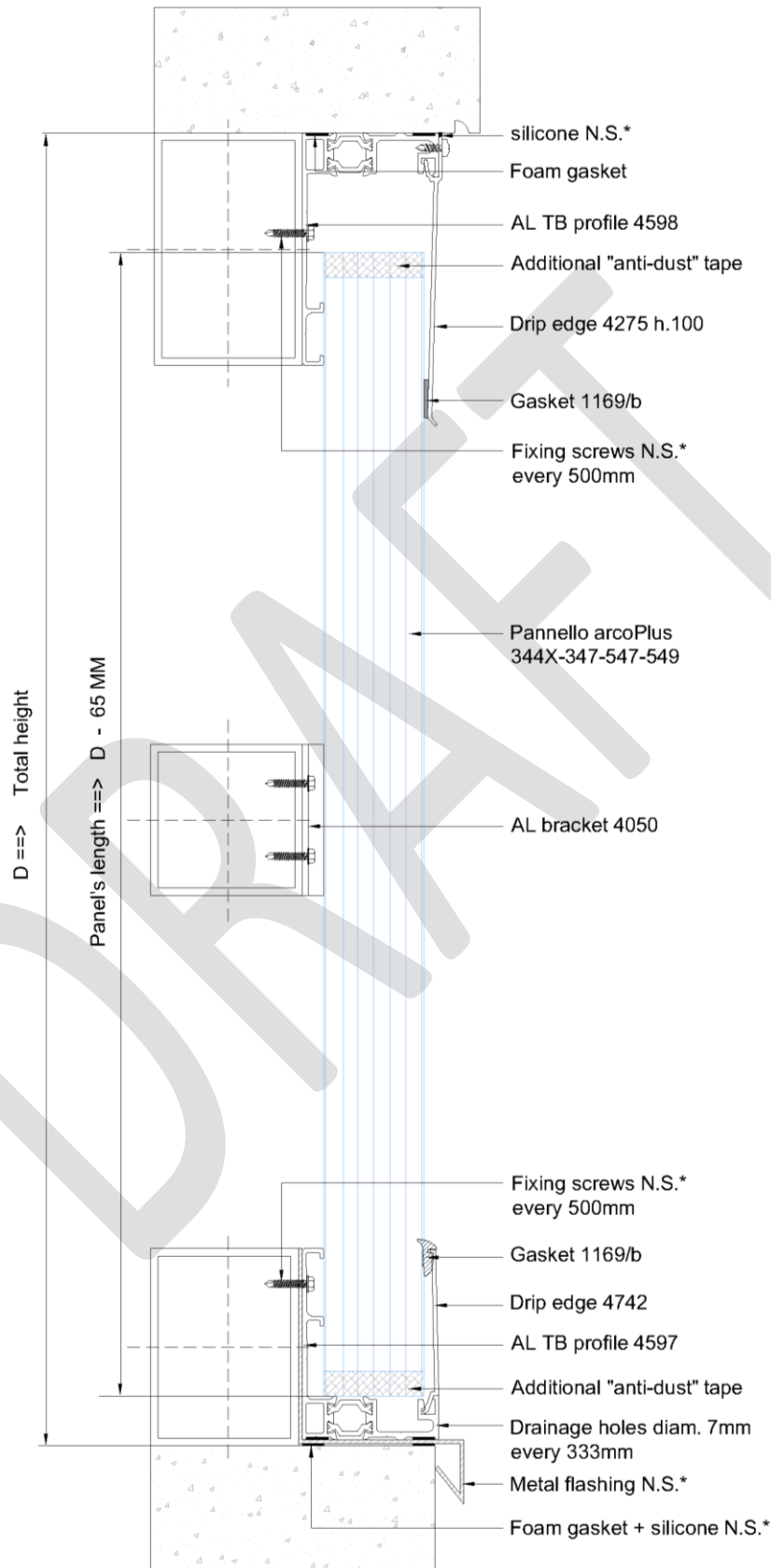

N.S.* = Not supplied by Gallina

Expansion joint detail with profile 4598

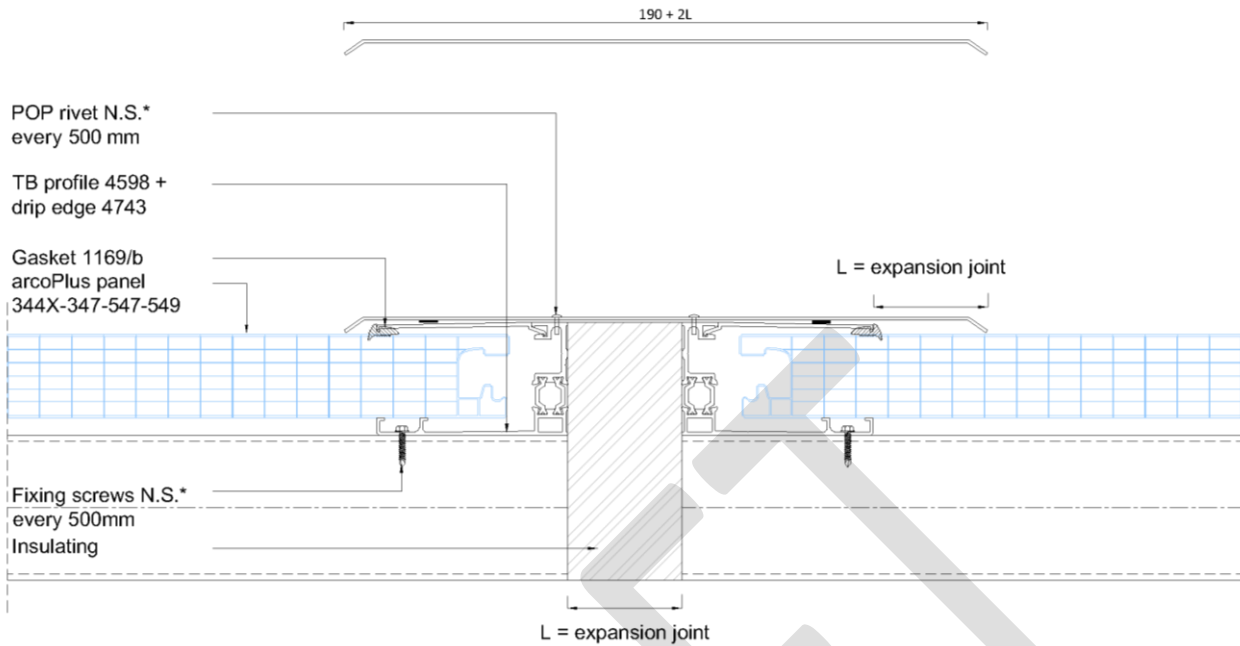

Corner detail with TB profiles cod. 4598

